



# CONSTRUCTION PTO Driven Heads



## 6 ABOUT FAE

## 8 CONSTRUCTION PTO DRIVEN HEADS

## 10 ADVANTAGES OF FAE MACHINE

## 12 SOIL STABILIZERS

16 STABI/FRS - STABI/FRS/HP

18 STABI/H - STABI/H/HP- **NEW**

20 TRANSMISSION (STABI/FRS)

22 TRANSMISSION (STABI/H)

26 VARIABLE GEOMETRY CHAMBER  
(STABI/H)

28 A/3 ROTOR (STABI/FRS - STABI/H)

30 TEETH - A/3 ROTOR

(STABI/FRS - STABI/H)

32 FRAME (STABI/FRS - STABI/H)

36 WATER SPRAY SYSTEM - HIGH FLOW  
(STABI/FRS - STABI/H)

38 FULL CONTROL SYSTEM

(STABI/FRS - STABI/H)

## 40 MULTITASKS

44 MTL

46 MTM - MTM/HP

48 MTH - MTH/HP

50 TRANSMISSION

52 VARIABLE GEOMETRY CHAMBER  
(MTL - MTM - MTH)

54 G/3 - ROTOR  
(MTL - MTM - MTH)

56 TEETH - G/3 ROTOR  
(MTL - MTM - MTH)

58 R - ROTOR (MTL - MTM - MTH)

60 TEETH - R ROTOR  
(MTL - MTM - MTH)

62 FRAME (MTL - MTM - MTH)

66 WATER SPRAY SYSTEM -  
BASIC & HIGH FLOW (MTL)

68 WATER SPRAY SYSTEM - HIGH FLOW  
(MTM - MTH)

70 FULL CONTROL SYSTEM



## MAKE THE **DIFFERENCE**

At FAE, every machine, accessory and optional component is designed with utmost precision, the highest quality materials and the most advanced technology.

Each detail is designed to make the execution of the tasks as quick and efficient as possible and for the specific applications, conditions and environment where it will be carried out.

Every FAE machine and accessory was created to make a difference at work and, given the importance of many of the applications we work on, for the planet. This is why each member of our team, each partner and customer works daily.



# ABOUT **FAE**

With a range of over 90 products and 400 models, FAE can meet the most diverse demands for forestry, agricultural, road construction, building and demining applications. The FAE product range includes heads for tractors, excavators, skid steer loaders, special vehicles and tracked vehicles, with cabins or remote controlled. FAE was founded in 1989, and the company's main office is still located in Fondo, Italy. Production, sales, after-sales service and parts services are handled by our 4 production sites, the main office, 6 commercial branches and a network of authorized dealers all over the world.

## **GLOBAL QUALITY**

Our precision design and production processes use advanced technologies to ensure long-term performance and reliability.

## **CONSTANT INNOVATION**

We design unique and cutting-edge technologies based on customers' specific needs for solutions that pave the way to the future.

## **COMPLETE PRODUCT LINE**

We guarantee an extensive product range and a high degree of customization to make each process more efficient, more productive, and easier.

## **TOTAL SUPPORT**

We make our vast range of machines, dedicated accessories and components, as well as our technical assistance available worldwide.

# CONSTRUCTION PTO DRIVEN HEADS

Our Construction line of machines brings the very latest technology to the industry. Making your road work easier, even in the most difficult conditions. Our cutting-edge engineering brings you a wide range of efficient attachments that are able to speed up and simplify the main jobs in the development of roads, highways and other infrastructure works.



# ADVANTAGES OF FAE MACHINES

Our line of construction machines bring the very latest technology to road work, making your job easier, even in the most difficult conditions. Our cutting-edge engineering brings you a range both of versatile and functional machinery that is reliable and efficient. Each machine possesses the ability to speed up and simplify the main jobs in the construction and development of roads, highways and other infrastructure works.

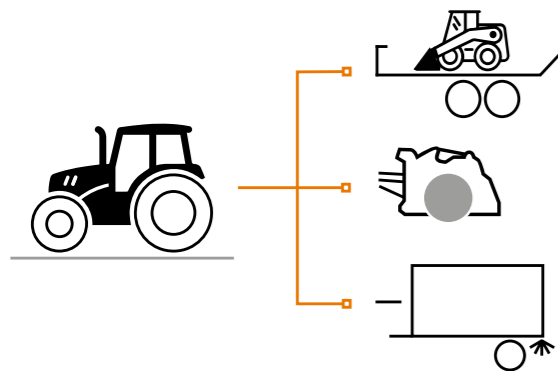

## VERSATILE

The tractor, which was just being used to operate other machinery, can be quickly equipped with a construction attachment.

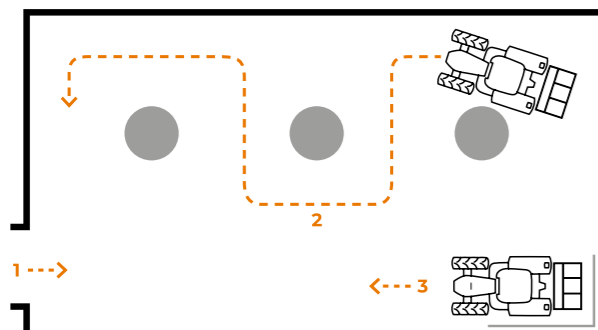

## MANEUVERABLE

- 1 / Use in areas with limited access
- 2 / Easy to use even in the presence of obstacles
- 3 / Perfect performance around curves and hard-to-access areas



## DYNAMIC

Moving from one site to another its easy and fast.



## PROFESSIONAL WATER SYSTEM

This option allows to set the quantity of water to be injected directly from tractor cab, according to the working depth and forward speed.

(Only available on certain models.)



## VARIABLE GEOMETRY CHAMBER

The result is a homogeneously stabilized soil at all working depths.

(Only available on certain models.)

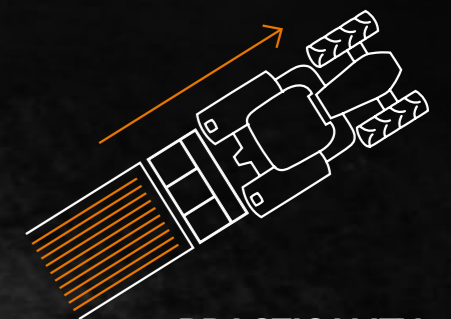

## PRACTICALITY

Quality final product, including mixing ability and final grade of the ground. The rear mounting allows tractor not to pass over the freshly milled ground.

## ® PATENTED TECHNOLOGY

Thanks to a patented system of cutting-edge tools and tool holders, you will always find the solution that suits your needs best.

# SOIL STABILIZERS

Thanks to the design of the chamber and a variety of teeth available, our FAE stabilizer is capable of producing both refined and mixed cement even when rocks are present.



**STABI/FRS - STABI/FRS/HP**

The essence of stabilization.



**STABI/H - STABI/H/HP**

Excellence in soil stabilization.



# THE IDEAL SOLUTIONS FOR ULTIMATE PRODUCTIVITY IN SOIL STABILIZATION.

MODEL	300 - 400 hp	400 - 500 hp
<b>STABI/FRS</b> <b>STABI/FRS/HP</b>	300 - 500 hp	
<b>STABI/H</b> <b>STABI/H/HP</b>	300 - 500 hp	



## SOIL STABILIZERS

# STABI/FRS - STABI/FRS/HP

### The essential tool for stabilization.

The STABI/FRS for tractors from 300 to 500 hp is the definition of the perfect stabilizer. With a fixed-rotor system and high productivity, it is stable and strong, even on very hard ground with stones. The STABI/FRS can be used on small work sites as well as for major infrastructural work, such as on highways, parking lots

and airports. The protruding rotor facilitates stabilization at depth with minimal power absorption. The crushing chamber makes it possible to work the ground to a depth of 50 cm, ensuring an excellent mixing quality. The solid frame and use of wear-resistant materials provide excellent reliability over time.



300-500 hp



Depth 50 cm max

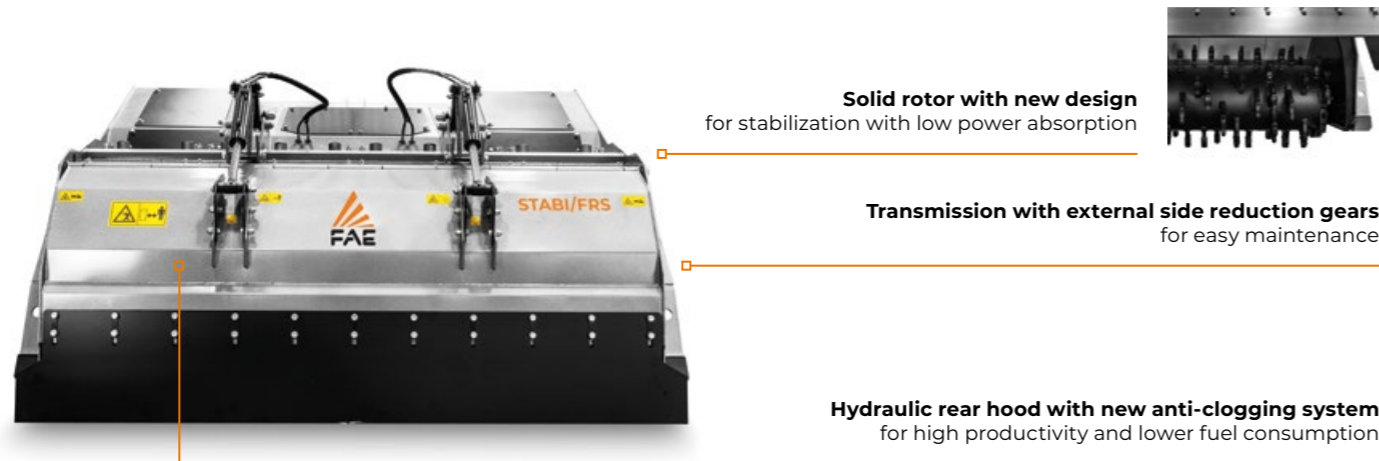

**Solid rotor with new design** for stabilization with low power absorption



**Transmission with external side reduction gears** for easy maintenance

**Hydraulic rear hood with new anti-clogging system** for high productivity and lower fuel consumption

**Oil cooling system** for gearbox and side reduction gears (STABI/FRS/HP)

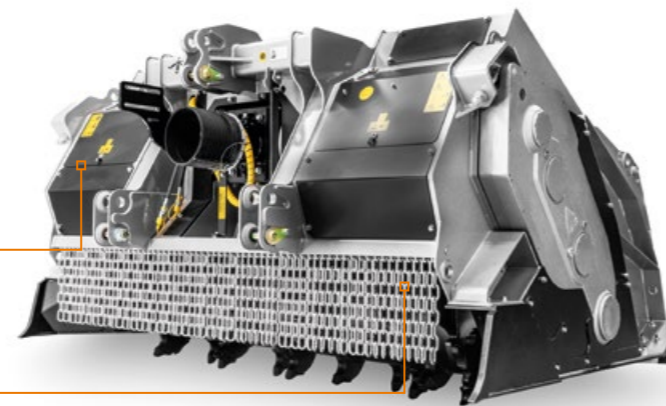

**Interchangeable Hardox® internal and side guards**

### MAIN OPTIONS

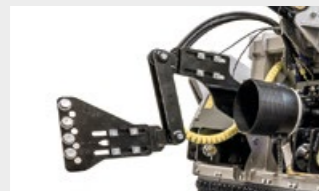

**W style self-aligning device between PTO drive shaft/gearbox** allows the mulcher to work in several angles without damaging the PTO



**Automatic FCS system** for optimal soil mixing and moisture management



**Dozing blade with springs system** to level and compact the crushed material, creating a uniform base

### STANDARD EQUIPMENT

Hydraulic rear Hood with anti-clogging system	Gearbox with freewheel
Interchangeable inner antiwear plates in Hardox®	Gearbox with oil cooling system (STABI/FRS/HP)
Enclosed machine body	PTO shaft
Inside lateral protection	Friction clutches
Protection chains	Bolted-on rotor shafts (in forged steel)
Transmission with side gearbox	Dozing blade
Side gearbox with oil cooling system (STABI/FRS/HP)	

### OPTIONS

Multiple tooth options	Dozing blades with spring system
Hydraulic top link	Water spray system WSS High Flow
W style self-aligning device between PTO drive shaft/gearbox	FCS full control system

MODEL	STABI/FRS 225	STABI/FRS 250	STABI/FRS/HP 225	STABI/FRS/HP 250
<b>Tractor (hp)</b>	300-400	300-400	400-500	400-500
<b>PTO (rpm)</b>	1000	1000	1000	1000
<b>Working width (mm)</b>	2320	2560	2320	2560
<b>Total width (mm)</b>	2750	2990	2750	2990
<b>Weight (Kg)</b>	6300	6500	6550	6750
<b>Rotor diameter (mm)</b>	1085	1085	1085	1085
<b>Max working depth (mm)</b>	500	500	500	500
<b>No. teeth</b> type A/3 + STC/FP + STC/3/FP + F/3/SS	64+4+4+4	68+4+4+4	64+4+4+4	68+4+4+4

Data refers to machine as standard. The technical data in this catalogue may be altered without prior notice.

### ROTOR TYPE A



**TOOTH A/3** (standard)



**TOOTH A/3/HD** (option)



**TOOTH F/3** (option)



**ADAPTOR F/3 WITH PICK R/44** (option)



**TOOTH STC/FP** (side scraper)



**TOOTH STC/3/FP** (side scraper)



**TOOTH F/3/SS** (side scraper)

NEW

SOIL STABILIZERS

# STABI/H - STABI/H/HP

## Excellence in soil stabilization.

The STABI/H is FAE's soil stabilizer for the most demanding professionals. It operates up to 56 cm deep and works with 300-500 hp tractors. The STABI/H is designed to prepare ground for building roads, highways, railroads, parking lots, sports complexes, office parks, industrial plants, and other infrastructure. The exclusive variable geometry

chamber allows the rotor to penetrate the soil using the movable frame, which is hydraulically adjustable with extreme accuracy right from the tractor's cab. Compared to a traditional machine, there is less traction stress, which means a lower power demand and less fuel needed.

 300-500 hp

 Depth 56 cm max

 Variable displacement chamber

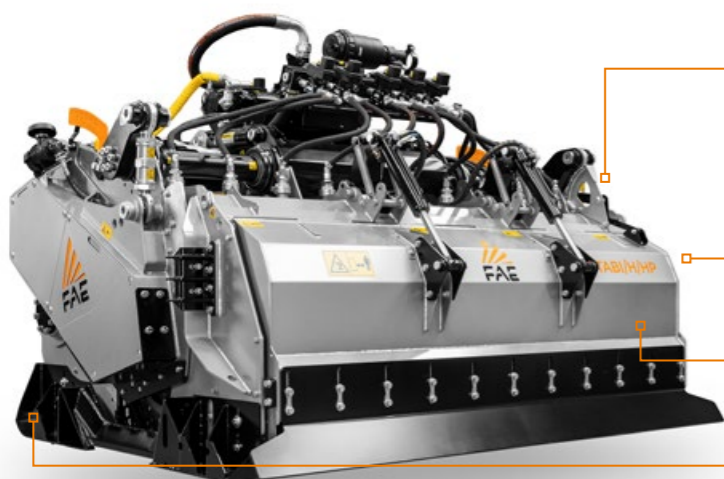

**Variable geometry chamber**  
for precise earthworking and to obtain an optimized mixture

**Hydraulic rear hood with new anti-clogging system**  
for high productivity and lower fuel consumption



**Solid mobile rotor**  
for stabilization with low power absorption

**Cogged belt transmission with reduction gear assembly**

**Oil cooling system for gearbox**  
(STABI/H/HP)



**Interchangeable internal Hardox® protections**



## MAIN OPTIONS



**Wide range of special teeth,** screwed on with plates in wear-resistant Widia®, which are interchangeable and suitable for a variety of applications



**FCS system** for optimal soil mixing and moisture management



**Dozing blade with springs system** to level and compact the crushed material, creating a uniform base



**Hydraulic top link**

## STANDARD EQUIPMENT

Hydraulic rear Hood with anti-clogging system	Side gearbox with oil cooling system
Interchangeable inner antiwear plates in Hardox®	Gearbox with freewheel
Enclosed machine body	Gearbox with oil cooling system (STABI/H/HP)
Variable displacement chamber	PTO shaft
Inside lateral protection	Friction clutches
Bolted on protection chains	Bolted-on rotor shafts (in forged steel)
Poly-Chain® belts transmission	Adjustable skids
Transmission with side gearbox	Dozing blade

## OPTIONS

Multiple tooth options	Water spray system WSS High Flow
Hydraulic top link	FCS full control system
Dozing blades with spring system	Anti clogging grid

MODEL	STABI/H 225	STABI/H 250	STABI/H/HP 225	STABI/H/HP 250
<b>Tractor</b> (hp)	300-400	300-400	350-500	350-500
<b>PTO</b> (rpm)	1000	1000	1000	1000
<b>Working width</b> (mm)	2293	2533	2293	2533
<b>Total width</b> (mm)	2664	2904	2664	2904
<b>Weight</b> (Kg)	7300	7450	7350	7500
<b>Rotor diameter</b> (mm)	1235	1235	1235	1235
<b>Working depth</b> (mm)(Max. 1 - Max. 2)	165-560	165-560	165-560	165-560
<b>No. teeth</b> type A/3+STC/3+STC/3/SS	64+4+8	72+4+8	64+4+8	72+4+8

Data refers to machine as standard. The technical data in this catalogue may be altered without prior notice. **Max. 1:** with rotor only **Max. 2:** maximum depth (maximum working depth depending on ground conditions).

## ROTOR TYPE A



**TOOTH A/3**  
(standard)



**TOOTH A/3/HD**  
(option)



**TOOTH F/3**  
(option)



**ADAPTOR F/3 WITH PICK R/44**  
(option)



**TOOTH STC/3/SS**  
(side scraper)



**TOOTH STC/3**  
(side scraper)

## CAST IRON HELICAL GEAR BOXES

Designed to create the least possible obstruction to penetration into the soil, the gear box is easily removable. It is secured by an oscillating system and independently supported by frame and rotor, thus it does not undergo stress from the frame and therefore, possible deformation.

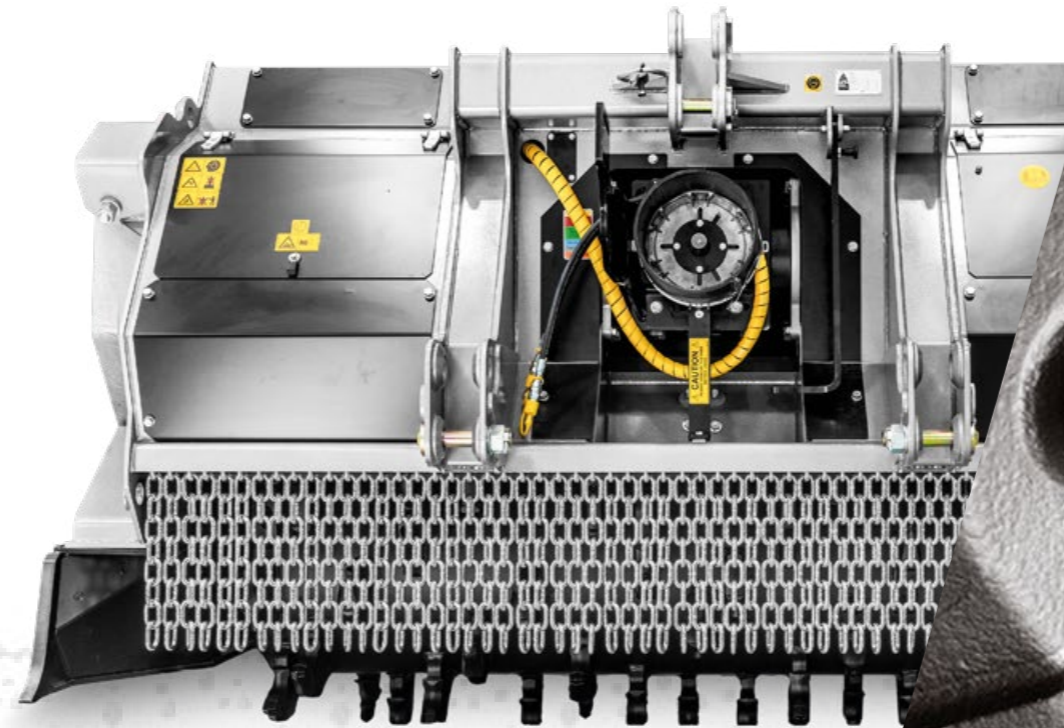

### DUAL LATERAL GEARBOX TRANSMISSION

The dual lateral gearbox transmission perfectly transforms engine power into grinding power. Compared to a belt driven transmission, the gearbox transmission offers important advantages such as: 1) greater transmission torque, 2) less tool wear because of lower rotor rotation speeds, 3) more effective ground penetration due to smaller size.

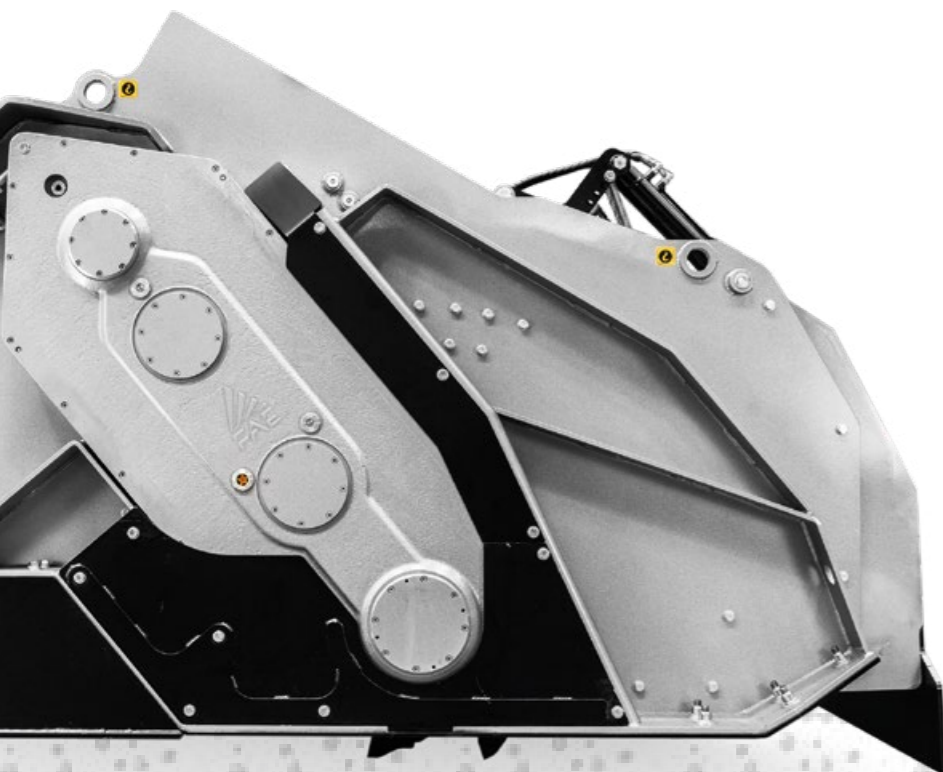

### GEAR REDUCTION SYSTEM

The single and dual gear reduction system, depending on the model, requires no forced hydraulic fluid cooling under most working conditions.

This component's high heat tolerance is a significant feature as it avoids the need for high maintenance parts such as oil coolers and pumps.

# GEARBOX WITH DUAL LATERAL TRANSMISSION



The dual lateral gearbox transmission with Poly-Chain® belt, together with a rotor-integrated transmission (available only for STABI/H model) excellently transforms the tractor power into cutting power.

## MECHANICAL TRANSMISSION WITH POLY-CHAIN® BELTS

The dual transmission transforms the power of the engine into high-performance grinding and mixing capability. Since the rotor is independent, the side transmission housings stay above ground during operations.



This dual transmission transforms tractor power into cutting power for productivity at maximum levels with minimal maintenance.

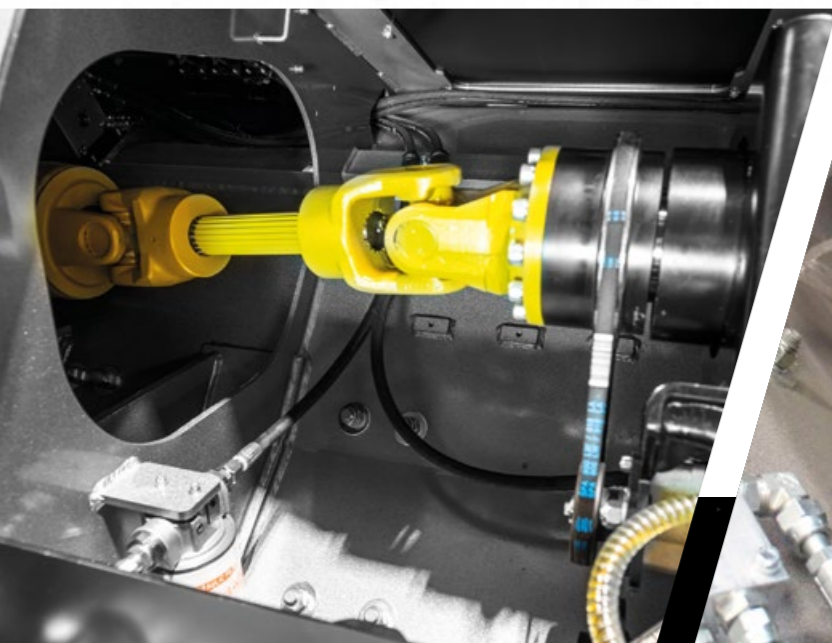

**FRICTION CLUTCH**



**LIQUID COOLED CENTRAL GEARBOX**

Only for 500 HP versions.



**EXTENSION SHAFT**

Designed to transfer the PTO power to the belt driven gear box.

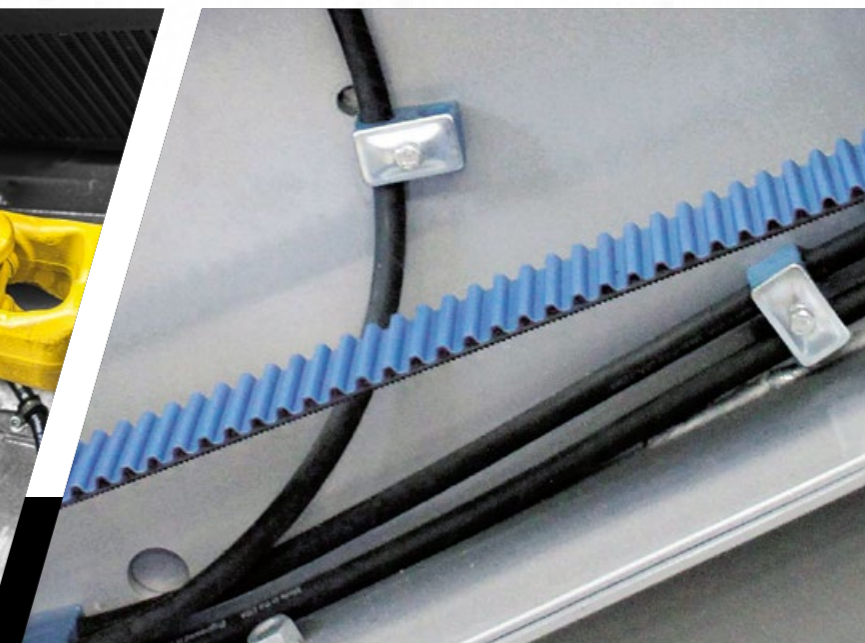

**POLY-CHAIN® BELTS**

There is a polychain belt transmission with carbon reinforcements on each side of the rotor.

# POWER IS TRANSFORMED INTO PRODUCTIVITY

The dual side combined transmission Polychain belts & Integrated gearboxes is the real base of multiple technology and productivity advantages.

- Efficient and reliable technology to transmit tractor engine power into working power
- Lower rotor speed get by the Integrated gearboxes that ensure a less teeth wear
- Cast iron made side Integrated gearboxes designed by FAE keeping so high quality standard levels in terms of technology and manufacturing process
- Integrated gearboxes bolt-on integrated into the rotor with offset shafts layout able to provide and extended rotor protrusion and ensure a more effective working depth  
Detail that permits an optimal side transmission layout keeping the belts side covers over the soil level in any working condition, allow an easier soil penetration with reflex on lower power absorption.
- Integrated gearboxes made by heavy duty and oversized components or applications under high torque and high loads working conditions
- Integrated gearboxes with additional oil cooling system for an improved reliability and efficiency in all working condition. Sensors ensure an increased reliability
- Poly-Chain® belts with carbon reinforcements can for extraordinary loads absorption, maintenance-free, heavy-duty strength and durability

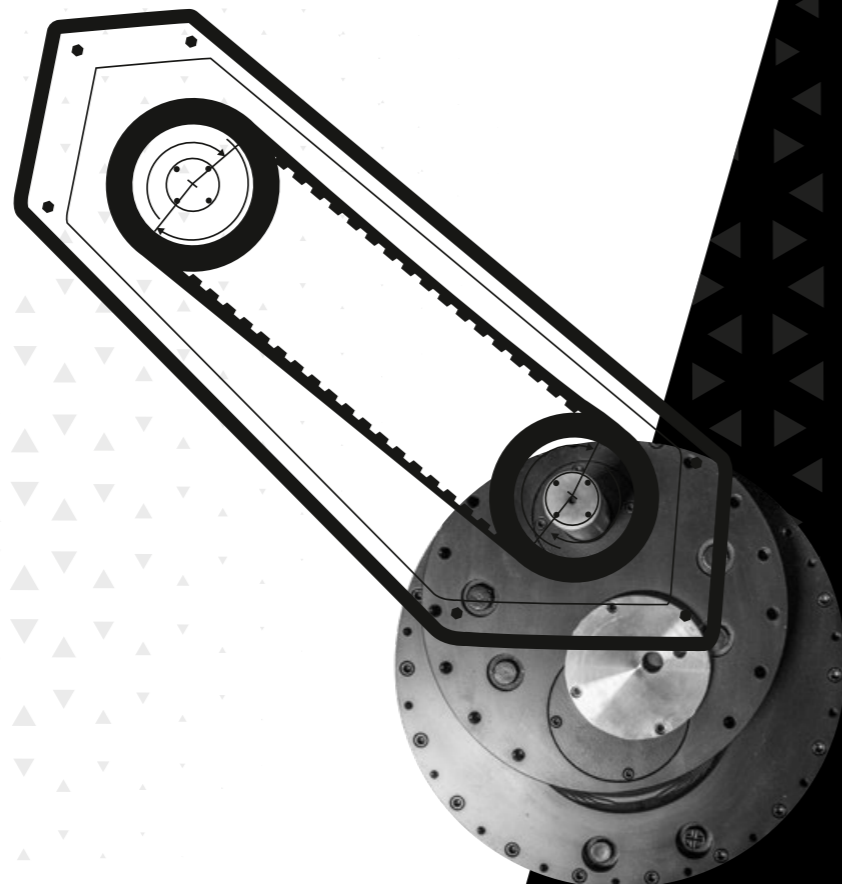

## COOLING SYSTEM

To guarantee the perfect operation of the machine, even in extreme conditions, we have developed a cooling system for the inner gearbox.

A fan pushes clean air from the outside to the inside. This helps to lower working temperatures and reduces maintenance as a result. The radiator, which is protected by a metal filter, keeps things cool no matter the conditions.

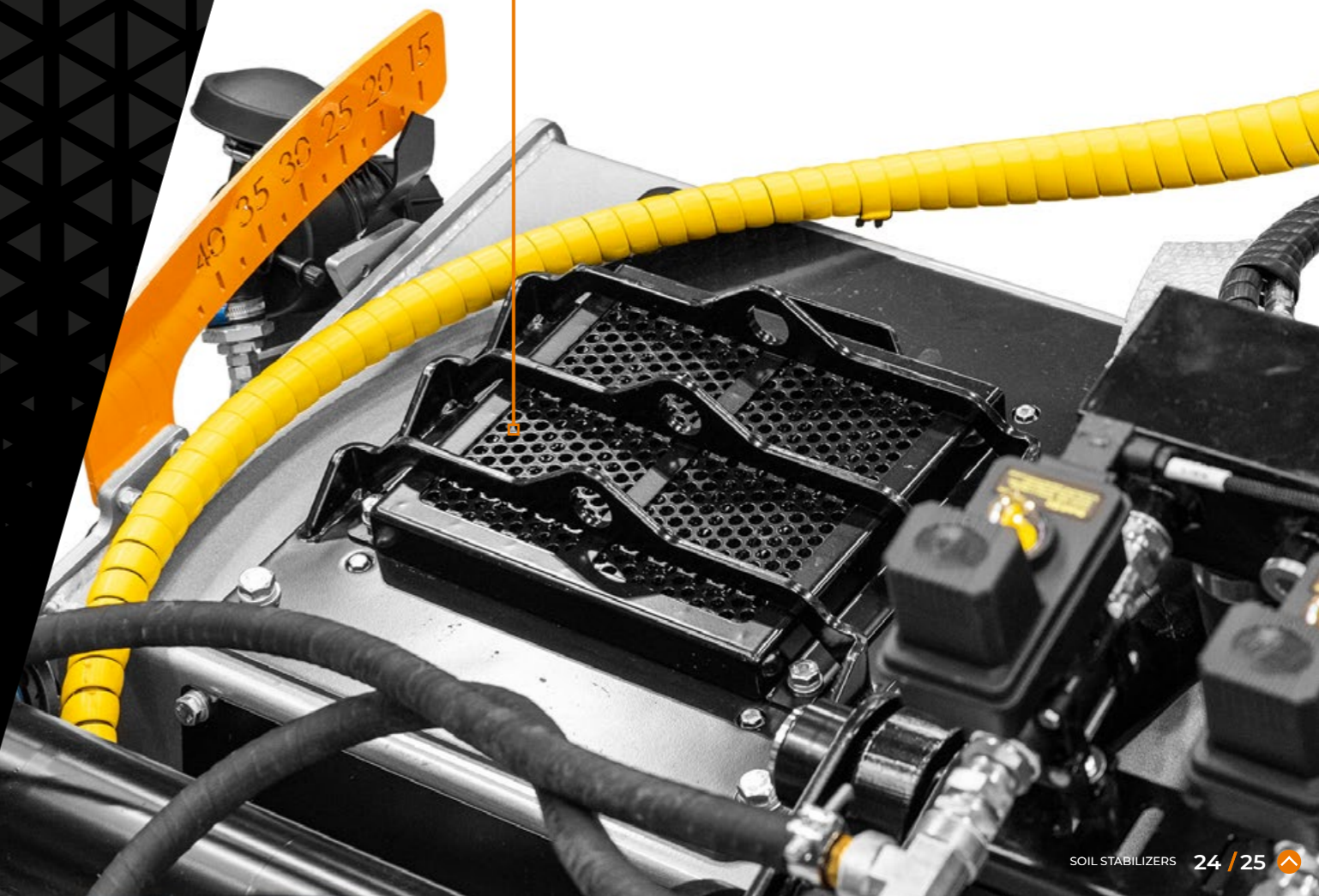

# VARIABLE GEOMETRY MIXING CHAMBER

The variable geometry chamber enables ground penetration with just the rotor, which may be adjusted from the tractor cab. The volume of the mixing chamber, where the material is blended, is variable for the deeper the work, the larger the volume of the chamber. Compared with machines that sink into the ground with their entire frame, the variable geometry mixing chamber reduces traction forces, lowers fuel consumption, speeds operations and saves time.

**LOWER SIDE PROTECTION GUARANTEES RELIABILITY EVEN AT MAXIMUM WORKING DEPTH**



- Guaranteed mixing quality of the material in any situation
- Increased operating speeds and greater time savings
- Reduced traction forces and fuel consumption
- Depth gauge to monitor and achieve proper depth
- Easily visible from the cab, for precise, efficient depth adjustment
- Newly engineered rotor depth control system

## DEPTH IS ADJUSTED USING 2 CYLINDERS

**STABI/H: 165 mm\***  
\*with rotor type A/3

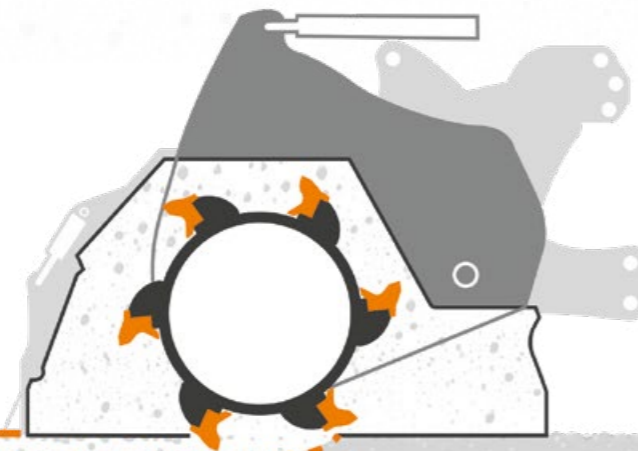

## SPECIALLY DESIGNED TO ACHIEVE A CONSISTENT DEPTH

**STABI/H: 405 mm\***  
\*with rotor type A/3

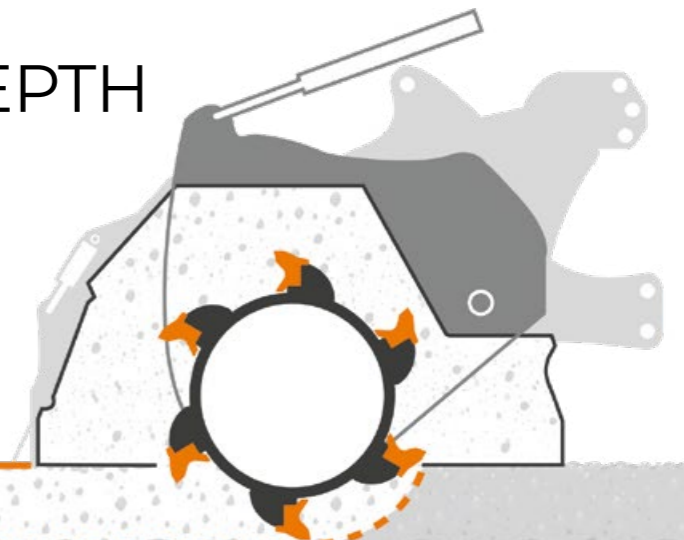

# EVEN MATERIAL DISTRIBUTION AND MIXING, EVEN FOR THE MOST DIFFICULT SOIL TYPES

## THE ROTOR

The core of FAE technology is the rotor, which mixes the ground and evenly mixes lime or cement spread over the area to be stabilized. The special set up of the tools ensures even distribution of the forces over it's the rotor's entire width, limits stress to the structure, reduces power absorption, and enables uniform distribution of the output materials. The rotor is equipped with different types of tools depending on the application.

A/3 ROTOR (STABI/F/RS)

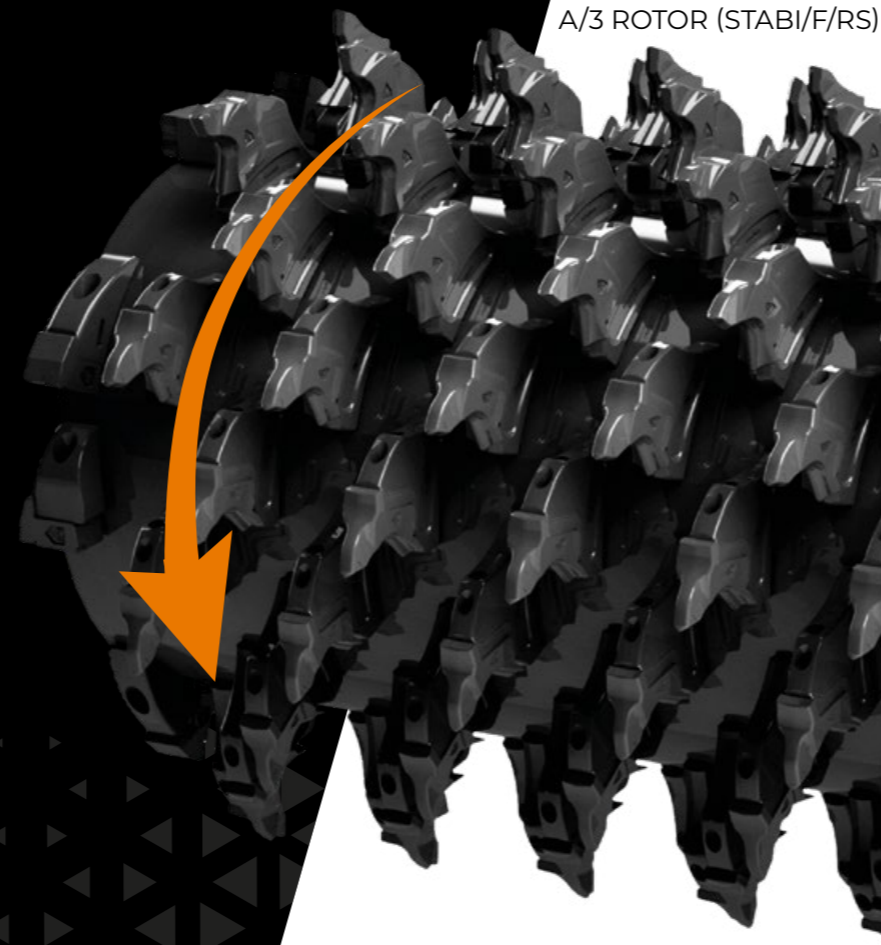

A/3 ROTOR (STABI/H)



A/3 ROTOR (STABI/F/RS)



A/3 ROTOR (STABI/H)

A/3 ROTOR (STABI/F/RS)



A/3 ROTOR (STABI/H)

The **rotor hubs** are interchangeable and made of forged steel for excellent resistance to mechanical stress.

**Guards** with easily replaceable parts.

The ends of the rotor as well as the outside tooth holders have been equipped with **wear plates** to protect them from excessive wear and tear.

A **labyrinth ring system** prevents dust from contaminating the transmission.



# YOU CAN BE CONFIDENT OF DURABILITY

Our teeth and tooth holders are the result of intensive research and development. The tooth holders are all made of forged steel, and welded to the rotor automatically. Tungsten carbide (Widia®) inserts offer hardness with limited wear and tear. The special design of FAE teeth guarantees the following advantages:

- 1** MAXIMUM RESISTANCE TO MECHANICAL STRESS
- 2** TOOLS LAST LONGER
- 3** MAXIMUM RELIABILITY AND PERFORMANCE EVEN IN TOUGH TERRAIN
- 4** REDUCED OPERATING COSTS

Thanks to the special design, the teeth use its shape to protect both the rotor and the tooth holder. Improved resistance to mechanical stress and maximum durability are the result of a larger support surface on the rotor.



**TOOTH STC/FP** (side scraper) Standard STABI/FRS  
**TOOTH STC/3/FP** (side scraper) Standard for STABI/FRS  
**TOOTH F/3/SS** (side scraper) Standard for STABI/FRS  
**TOOTH STC/3/SS** (side scraper) Standard for STABI/H  
**TOOTH STC/3** (side scraper) Standard for STABI/H



**TOOTH A/3**  
(standard)



**ADAPTOR F/3 WITH PICK R/44**  
(optional)



**TOOTH A/3/HD**  
(optional)



**TOOTH F/3**  
(optional)

### GROUND STABILIZING

Recommended for stabilization ground free of rocks, and other extreme, or abrasive materials.  
TOOTH A/3

Recommended for penetration of thin asphalt and stabilizing ground free of rocks, and other, extreme, or abrasive materials. Includes tooth adaptor as well as asphalt bit.  
ADAPTOR F/3 WITH PICK R/44

### STABILIZE ESPECIALLY ROUGH SOIL

Recommended for penetration of thin asphalt and stabilizing ground free of rocks, and other, extreme, or abrasive materials. Includes tooth adaptor as well as asphalt bit.  
TOOTH A/3/HD

### ASPHALT GRINDING

Recommended for penetration of thin asphalt and stabilizing ground free of rocks, and other, extreme, or abrasive materials. Includes tooth adaptor as well as asphalt bit.  
TOOTH F/3

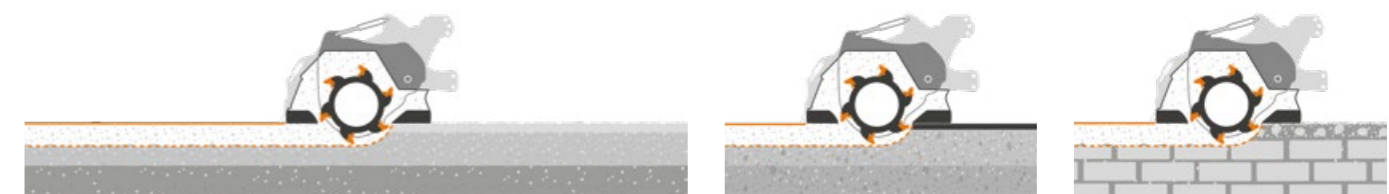



# ENDURING THROUGH TIME, DESIGNED FOR EVERY NEED

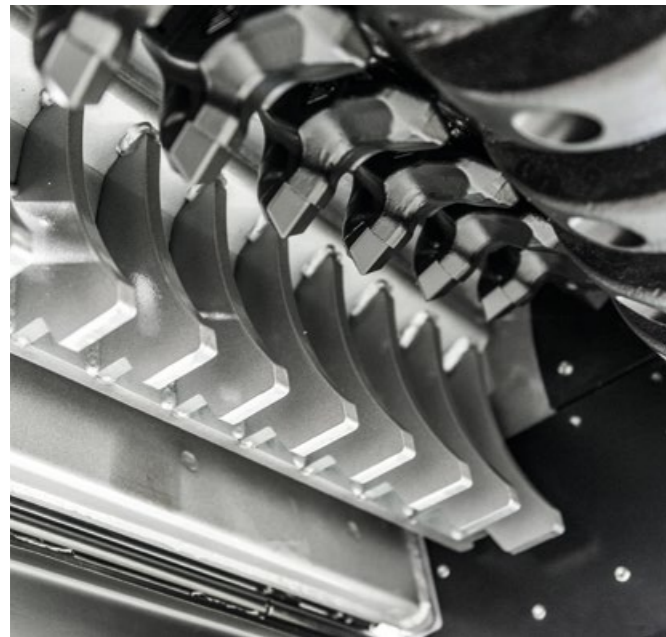

## REAR GRID (STABI/FRS)

The grid on the rear door helps define the size of the output material. Its use is advantageous in wet working conditions and with clay-based soil. The grid enables the rear door to remain more open so that the soil can flow out without losing the mixing quality.



## HARDOX® SECTIONAL WEAR PLATES

Internal Hardox® guards against wear and tear. The sectional plates are easy to replace without having to remove the rotor.

## REAR HYDRAULIC DOOR

Designed especially with hydraulic adjustments to control the amount of outgoing material.

## OPENING FOR MATERIAL

The wide opening is designed specifically to work at extensive depths. The protection chains reduce stone projectiles and dust - a simple and effective solution.

## INSPECTION DOOR WITH KEY CLOSURE

The special design of the hatches ensures easy maintenance operations. The key closure, specially designed with an incorporated dust screen, allows the quick opening of both hatches in any situation.

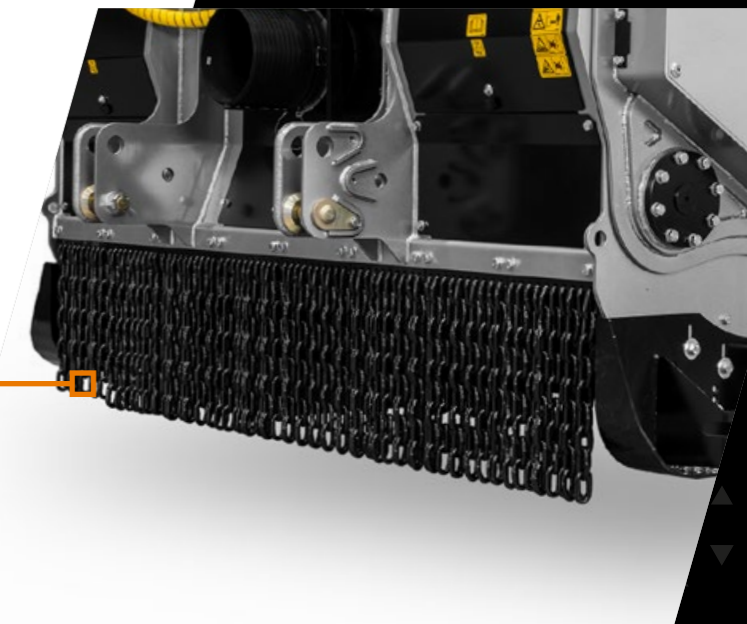
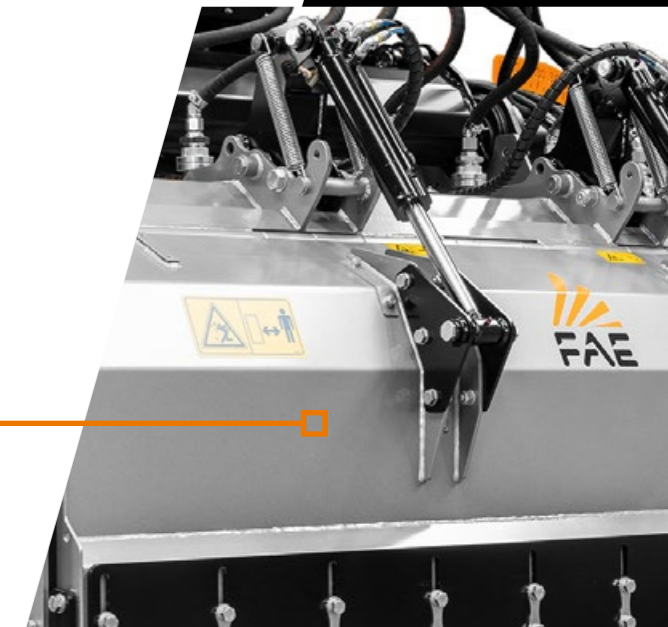

# FOR TOP LEVEL PERFORMANCE THE DIFFERENCE IS IN THE DETAILS

## SPRING LOADED LEVELING BLADE

The spring loaded leveling blade produces an even final product as a result of its engineering and design.

## STRUCTURAL PLATES WELDOX®

To ensure high strength and easy handling.

## TEFLON INSERTS

(only for STABI/H) Easily replaceable, they ensure that the two frames slide easily.



1.

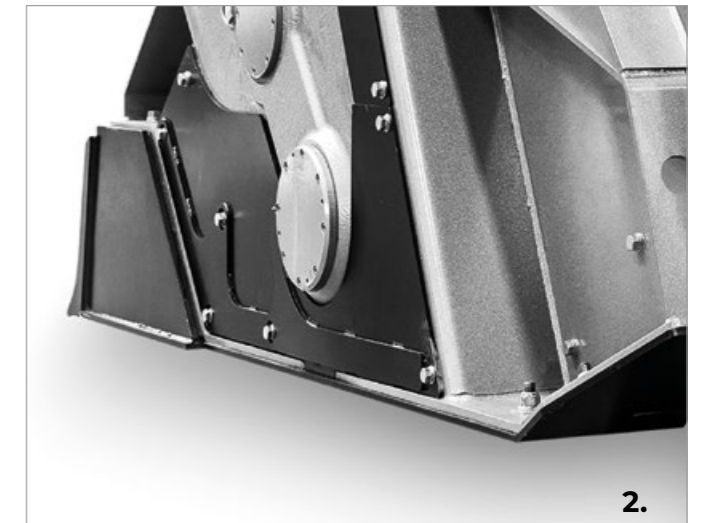

2.

### 1. ADJUSTABLE, INTERCHANGEABLE SKIDS WITH WEAR-RESISTANT SKIDS PLATES + PENETRATION SKIDS (STABI/H and STABI/H/HP)

### 2. SKIDS + LONG-WEARING, INTERCHANGEABLE SKIDS PLATES (STABI/FRS and STABI/FRS/HP)

This option provides maximum operating stability, allowing the machine to “float” on the ground. The adjustable model lets you adjust the blade height to meet the specific needs of the application. Easily removable, they have wear-resistant Hardox blades made for working at depth. If only used without the skids, the penetration blades welded to protect the frame from wear and tear make it easier for the machine to penetrate the ground and can reach up to 56 cm deep.



The skid can be easily detached and protects the frame against wear and tear.

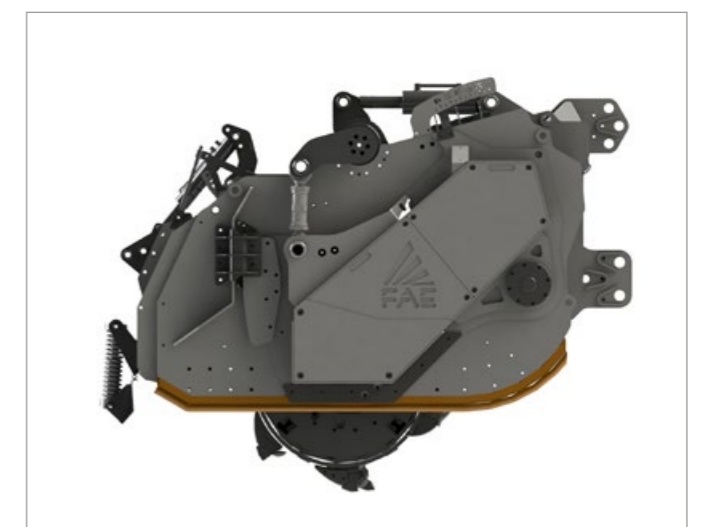

The penetration skid extends the working depth and also protects the frame.

# ALL MACHINES CAN BE EQUIPPED WITH A WATER INJECTION SYSTEM

(EVEN AT A LATER DATE)

## WATER SPRAY SYSTEM HIGH FLOW (WSS FOR STABI/FRS - STABI/H)

Thanks to the control panel and display showing the water flow rate, it is possible to easily monitor and adjust, from the tractor cab and in complete safety, the instantaneous value of the liters of water delivered and the overall value from the beginning of the operations.

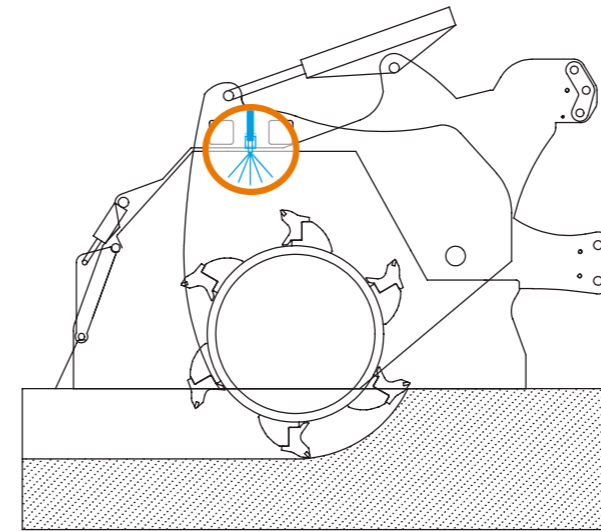
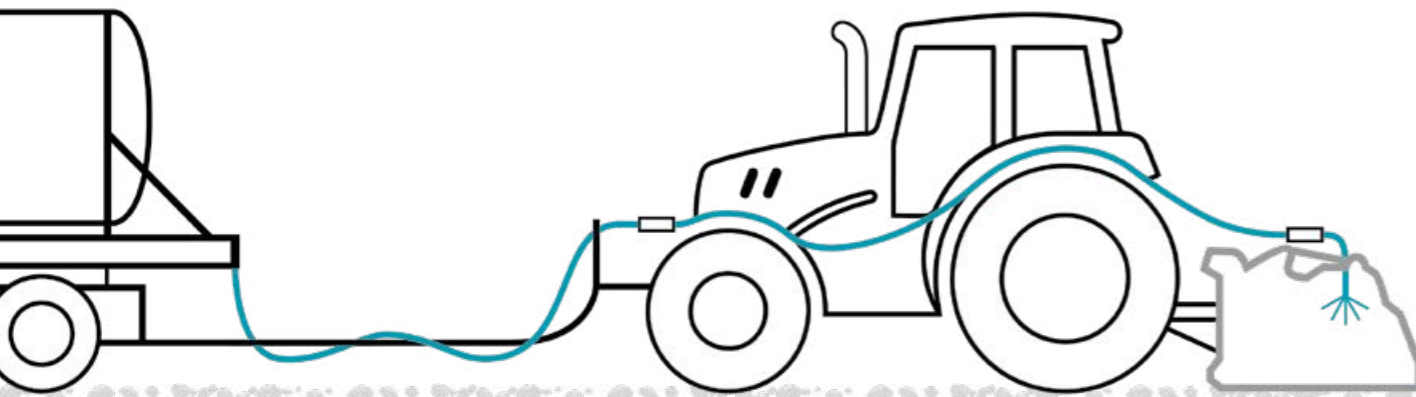

### MIXING FUNCTION

(only for stabilize machines or multitask machines)

This function increases the moisture level in the soil, improves mixing with the stabilising agent during stabilisation operations and optimises the results of the consolidation work. It also helps to ensure proper compaction. This is the ideal solution even for liquid binders mixed directly in the mixing chamber.

Water dispensing ON (nozzle up) or OFF (nozzle down)

Panel display ON/OFF

Check Panel functions

Water capacity adjustment (l/min)



STABI/FRS - STABI/FRS/HP  
STABI/H - STABI/H/HP

CAPACITY FROM  
SINGLE NOZZLE AT 3 BAR

CAPACITY FROM SYSTEM

<b>Optional nozzle "1"</b> (80° - 20 l/min)	7.9 l/min	65-110 l/min
<b>Optional nozzle "2"</b> (80° - 40 l/min)	15.8 l/min	115-235 l/min
<b>Optional nozzle "3"</b> (80° - 60 l/min)	24 l/min	150-330 l/min
<b>Standard nozzle</b> (80° - 100 l/min)	39 l/min	210-500 l/min
<b>Optional nozzle "4"</b> (80° - 150 l/min)	59 l/min	240-580 l/min
<b>Optional nozzle "5"</b> (80° - 200 l/min)	79 l/min	260-640 l/min

### HIGH FLOW WATER SPRAY SYSTEM - HIGH FLOW WSS

Each nozzle has an on/off valve allowing you to manage individual elements separately.

A vast choice of nozzle type, easily exchangeable according to the amount of water.



# HELPING YOU MAKE THE RIGHT CHOICES

## FCS FULL CONTROL SYSTEM (FCS for STABI/FRS - STABI/H)

The FAE automatic injection system, FCS, is a cutting-edge system built for excellent supply and distribution of water and/or to stabilize the fluid binding agent. Using this intuitive system, the operator is able to establish the exact amount of fluid from the display, based on the road surface (l/m<sup>2</sup>) or mixing volume (l/m<sup>3</sup>).



### SETTING STAGE

This allows you to choose the perfect nozzles for the job during the initial stages.



### WORK STAGE

All of the machine's vital parameters are monitored and recorded.



### ANALYSIS STAGE

The software lets you create a work report that can be easily saved to a USB drive (for example the number of m<sup>2</sup> or m<sup>3</sup> processed, water flow, etc.).



The advanced FCS is automatically calibrated according to the speed and depth of the job. The machine's sensors also ensure the correct, automatic operation of this cutting-edge system.

The material is mixed to the moisture ratio required to achieve perfect stabilization.

Compared to manual adjustment, the FCS leaves no room for error and ensure the best possible results in every application.

The machine sensors ensure correct and automatic operation of this first-class system.

The system constantly monitors forward feed speed through the ISOBUS connection on the tractor, or via optional radar sensor, while other sensors control the working depth.

A magnetic flow meter ensure the capacity required.

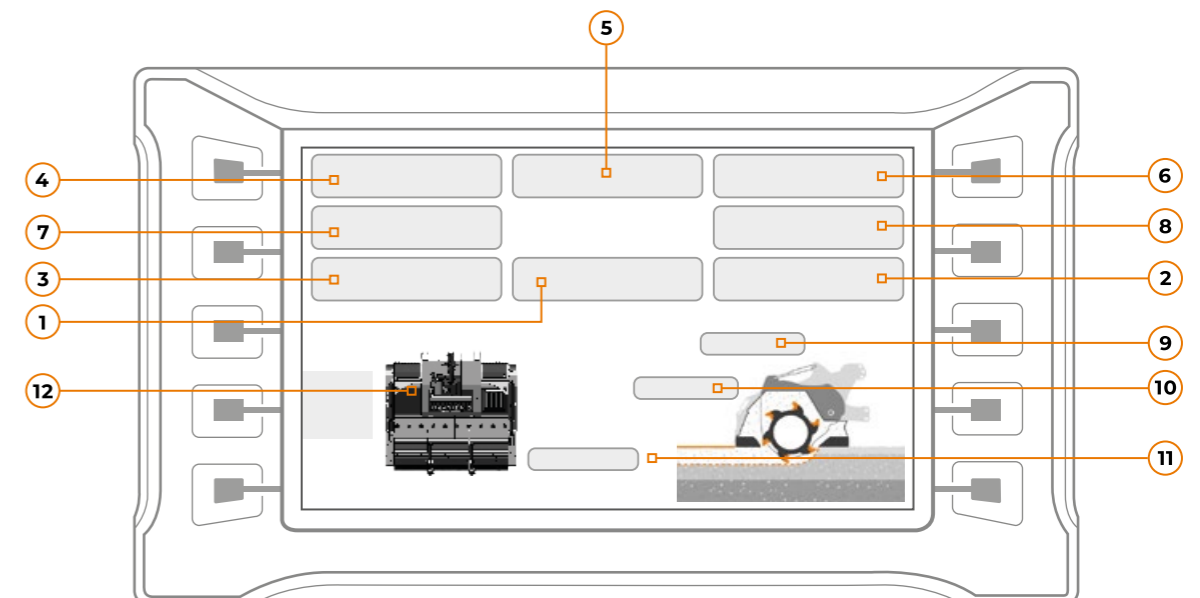

1. Current speed
2. Current injection flow
3. Total flow from the start of the job
4. Area covered
5. Delivery requirement (l/m<sup>2</sup>)
6. Current delivery (l/m<sup>2</sup>)

7. Volume mixed
8. Current delivered (l/m<sup>3</sup>)
9. Rotor movement percentage
10. Percentage of rear panel opening
11. Working depth
12. Number of nozzles open

# MULTITASKS

Our Multitask machines offer you an unmatched advantage: being able to use a single machine to perform different operations. Thanks to a mixing chamber and to the wide selection of tools, these machines can crush stones, stabilize soil and, in certain conditions, shred asphalt for road building and maintenance purposes.



## MTL

FAE multi-function head for tractors from 140 to 240 hp.



## MTM - MTM/HP

FAE multi-function head for tractors from 240 to 360 hp.



## MTH - MTH/HP

FAE multi-function head for tractors from 300 to 500 hp.



## MULTITASKS

# MULTIPURPOSE USES FOR **EXCELLENT RESULTS.**

MODEL	100 - 200 hp	200 - 300 hp	300 - 400 hp	400 - 500 hp
<b>MTL</b>	140 - 240 hp			
<b>MTM - MTM/HP</b>		240 - 360 hp		
<b>MTH - MTH/HP</b>			300 - 500 hp	

MULTITASKS

# MTL

## FAE multi-function head for tractors from 140 to 240 hp.

The MTL enables ground stabilization, milling of asphalt and slabs of rock, and crushing of stones, down to a maximum operating depth of 28 cm. The variable-geometry crushing chamber, adjustable grid on the hood and adjustable Hardox® counter blade enable constantly optimal crushing results. Internal protection plates on the frame, bolted both centrally

and laterally, ensure the head is robust and reliable. The handy depth indicator allows you to check the operating level directly from the cab. The central gearbox system with universal-joint alignment system is designed to be compatible with a wide range of tractors on the market.



140-240 hp



Depth 28 cm max



Variable displacement chamber



**Side wear plates on the inner sides of the frame** highly resistant to wear and tear, equalling less down time due to replacement



**Rear access panel**

**Hardox® steel - Wear plates** these allow the machine to resist wear and tear and can be easily replaced as needed



**Rear grid** the grid on the rear door helps define the size of the output materials



**Displacement Chamber** this technological solution, which is one of a kind in the industry, allows the ground to be penetrated with the rotor alone

### STANDARD EQUIPMENT

Hydraulic rear hood	Transmission with side gearbox
Interchangeable inner antiwear plates in Hardox®	Gearbox with freewheel
Enclosed machine body	Friction clutches
Variable displacement chamber	PTO shaft with cam clutch
Bolted grid on rear hood	Bolted-on rotor shafts (in forged steel)
Inside lateral protection	Adjustable Hardox® counter-blade
Bolted on protection chains	Dozing blades with spring system

### OPTIONS

Multiple tooth options	Water spray system WSS Basic
Hydraulic top link	Water spray system WSS High Flow

MODEL	MTL 150	MTL 175	MTL 200	MTL 225
<b>Tractor</b> (hp)	140-240	150-240	160-240	170-240
<b>PTO</b> (rpm)	1000	1000	1000	1000
<b>Working width</b> (mm)	1480	1720	1960	2200
<b>Total width</b> (mm)	1820	2060	2300	2540
<b>Weight</b> (Kg)	3370	3620	3870	4120
<b>Rotor diameter</b> (mm)	595	595	595	595
<b>ROTOR G/3</b>				
<b>Working depth</b> (mm) (Max. 1-Max. 2)	150-280	150-280	150-280	150-280
<b>No. teeth</b> type G/3+STC/3/FP	42+6	50+6	60+6	70+6
<b>Rotor diameter</b> (mm)	612	612	612	612
<b>ROTOR R (optional)</b>				
<b>Working depth</b> (mm) (Max. 1-Max. 2)	150-280	150-280	150-280	150-280
<b>No. picks</b> type R/65+R/65/HD	98+16	114+16	138+16	154+16

**Max. 1:** with rotor only **Max. 2:** maximum depth (maximum working depth depending on ground conditions). This information refers to the machine equipped as standard. The technical data in this catalogue may be altered without prior notice.

### MAIN OPTIONS



Hydraulic top link



Multiple tooth options



The **Water Spray System** (Basic & High Flow) has the dual function of cooling and mixing

#### ROTOR TYPE G



**TOOTH G/3** (standard)



**TOOTH G/3/HD** (option)

#### ROTOR TYPE R



**PICK R/65** (standard)



**PICK R/65/HD** (option)



**ADAPTOR R/65 WITH PICK R/44** (option)



**TOOTH STC/3/FP** (side scraper)



**PICK R/65/HD** (side scraper)

MULTITASKS

# MTM - MTM/HP

FAE multi-function head for tractors from 240 to 360 hp.

The MTM enables ground stabilization, milling of slabs of rock, crushing of stones, and milling of asphalt, down to a maximum operating depth of 40 cm. The compact size and excellent maneuverability enable the MTM to work on surfaces which are difficult to reach using self-powered vehicles. The variable-geometry crushing chamber guarantees excellent

results in terms of breaking down material. The volume of the chamber increases based on depth with a reduction in fuel consumption and an increase in operating speed. The Hardox® wear-resistant counter blade and grid on the rear hood guarantee the desired granulometry of material processed.

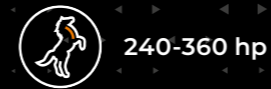

240-360 hp



Depth 40 cm max



Variable displacement chamber

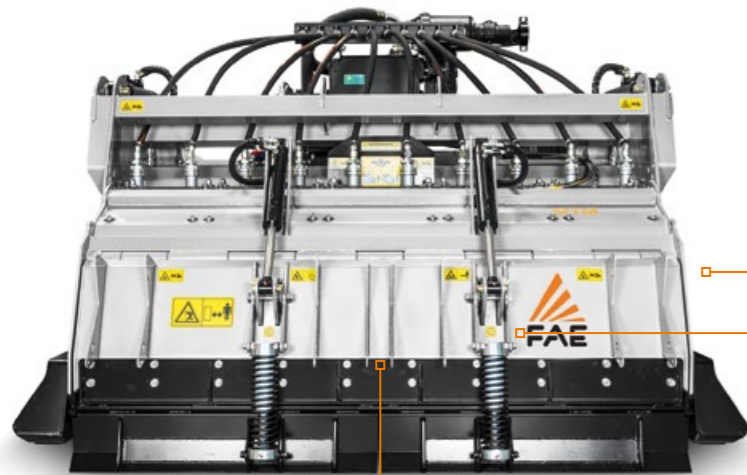

**Side wear plates on the inner sides of the frame**  
highly resistant to wear and tear, equalling less down time due to replacement



**Rear access panel**

**Hardox® steel - Wear plates**  
these allow the machine to resist wear and tear and can be easily replaced as needed

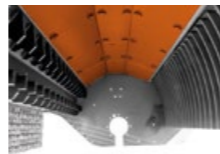

**Rear grid**  
the grid on the rear door helps define the size of the output materials

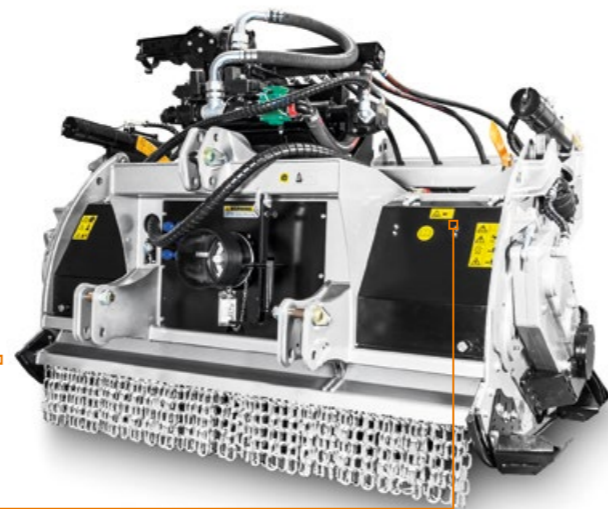

**Displacement Chamber**  
this technological solution, which is one of a kind in the industry, allows the ground to be penetrated with the rotor alone

**STANDARD EQUIPMENT**

Hydraulic front hood	Gearbox with freewheel
Hydraulic rear hood	PTO shaft (MTM/HP)
Interchangeable inner antiwear plates in Hardox®	Friction clutches
Enclosed machine body	PTO shaft with cam clutch (MTM)
Variable displacement chamber	Bolted-on rotor shafts (in forged steel)
Bolted grid on rear hood	Adjustable Hardox® counter-blade
Inside lateral protection	Adjustable skids
Protection chains	Dozing blades with spring system
Transmission with side gearbox	

**OPTIONS**

Extended 3 point linkage	Water spray system WSS High Flow
Multiple tooth options	FCS full control system
Hydraulic top link	

MODEL	MTM 200	MTM 225	MTM/HP 200	MTM/HP 225
<b>Tractor</b> (hp)	240-300	240-300	300-360	300-360
<b>PTO</b> (rpm)	1000	1000	1000	1000
<b>Working width</b> (mm)	2053	2293	2053	2293
<b>Total width</b> (mm)	2495	2735	2495	2735
<b>Weight</b> (Kg)	5850	6350	5900	6400
<b>ROTOR G/3</b>				
<b>Rotor diameter</b> (mm)	940	940	940	940
<b>Working depth</b> (mm) (Max. 1-Max. 2)	250-400	250-400	250-400	250-400
<b>No. teeth</b> type G/3+STC/3/FP+STC/FP	94+4+4	106+4+4	94+4+4	106+4+4
<b>ROTOR R</b>				
<b>Rotor diameter</b> (mm)	915	915	915	915
<b>Working depth</b> (mm) (Max. 1-Max. 2)	240-400	240-400	240-400	240-400
<b>No. pciks/teeth</b> type R/65+R/65/HD+STC/3/FP+STC/FP	126+20+4+4	144+20+4+4	126+20+4+4	144+20+4+4

**Max. 1:** with rotor only **Max. 2:** maximum depth (maximum working depth depending on ground conditions).  
This information refers to the machine equipped as standard. The technical data in this catalogue may be altered without prior notice.

**MAIN OPTIONS**



Extended 3 point linkage



Bolt-on chain's protection plates



Multiple tooth options

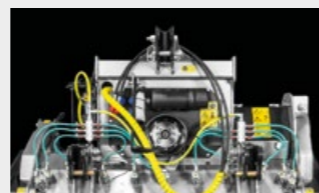

The **Water Spray System** (High Flow & FCS) has the dual function of cooling and mixing

**ROTOR TYPE G**



**TOOTH G/3** (standard)



**TOOTH G/3/HD** (option)



**ADAPTOR G/3 WITH PICK R/44** (option)

**ROTOR TYPE R**



**PICK R/65** (standard)



**PICK R/65/HD** (option)



**ADAPTOR R/65 WITH PICK R/44** (option)



**TOOTH STC/FP** (side scraper)



**TOOTH STC/3/FP** (side scraper)



**PICK R/65/HD** (side scraper)



MULTITASKS

# MTH - MTH/HP

## FAE multi-function head for tractors from 300 to 500 hp.

The top-of-the-range FAE multi-function machine enabling milling of rock slabs, crushing of stones, milling of asphalt and ground stabilization, with a maximum operating depth of 50 cm. The gear transmission enables operation with constantly optimal levels of torque and power. The variable-geometry crushing chamber guarantees excellent

results in terms of breaking down material. The volume of the chamber increases based on depth with a reduction in fuel consumption and an increase in operating speed. The Hardox® wear-resistant counter blade and grid on the rear hood guarantee the desired granulometry of material processed.



300-500 hp



Depth 50 cm max



Variable displacement chamber

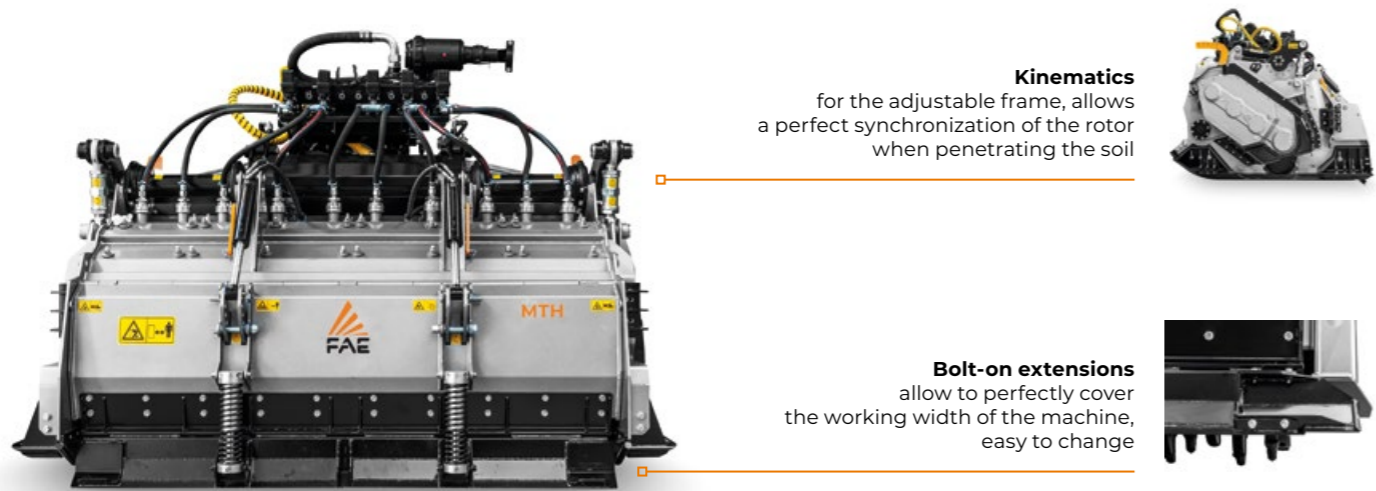

**Kinematics** for the adjustable frame, allows a perfect synchronization of the rotor when penetrating the soil



**Bolt-on extensions** allow to perfectly cover the working width of the machine, easy to change



**Cooling system** guarantees high performance in all working conditions

**Internal replaceable protections** to allow using the machine in extreme conditions



### STANDARD EQUIPMENT

Hydraulic rear hood	Gearbox with oil cooling system (MTH/HP)
Interchangeable inner antiwear plates in Hardox®	PTO shaft
Enclosed machine body	Friction clutches
Variable displacement chamber	Bolted-on rotor shafts (in forged steel)
Bolted grid on rear hood	Hydraulic top link
Inside lateral protection	Flat pressed welded steel counter-blades
Bolted on protection chains	Adjustable Hardox® counter-blade
Transmission with side gearbox	Adjustable skids
Side gearbox with oil cooling system (MTH/HP)	Dozing blades with spring system
Gearbox with freewheel	

### OPTIONS

Hydraulic front hood	Multiple tooth options
Extended 3 point linkage	Water spray system WSS High Flow
Centralized greasing hub	FCS full control system

MODEL	MTH 225	MTH 250	MTH/HP 225	MTH/HP 250
<b>Tractor</b> (hp)	300-400	300-400	360-500	360-500
<b>PTO</b> (rpm)	1000	1000	1000	1000
<b>Working width</b> (mm)	2320	2560	2320	2560
<b>Total width</b> (mm)	2901	3141	2901	3141
<b>Weight</b> (Kg)	7900	8150	8100	8325
<b>ROTOR G/3</b>				
<b>Rotor diameter</b> (mm)	1115	1115	1115	1115
<b>Working depth</b> (mm) (Max. 1-Max. 2)	320-500	320-500	320-500	320-500
<b>No. teeth</b> type G/3+STC/3/FP+STC/FP	116+4+4	132+4+4	116+4+4	132+4+4
<b>Rotor diameter</b> (mm)	1065	1065	1065	1065
<b>ROTOR R (optional)</b>				
<b>Working depth</b> (mm) (Max. 1-Max. 2)	340-500	340-500	340-500	340-500
<b>No. teeth</b> type R/65+R/65/HD+STC/3/FP+STC/FP	160+24+6+6	180+24+6+6	160+24+6+6	180+24+6+6

**Max. 1:** with rotor only **Max. 2:** maximum depth (maximum working depth depending on ground conditions). This information refers to the machine equipped as standard. The technical data in this catalogue may be altered without prior notice.

### MAIN OPTIONS



Extended 3 point linkage



Bolt-on chain's protection plates



Multiple tooth options

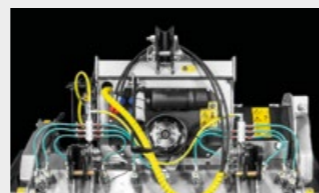

The **Water Spray System** (High Flow & FCS) has the dual function of cooling and mixing

#### ROTOR TYPE G



**TOOTH G/3** (standard)



**TOOTH G/3/HD** (option)



**ADAPTOR G/3 WITH PICK R/44** (option)

#### ROTOR TYPE R



**PICK R/65** (standard)



**PICK R/65/HD** (option)



**ADAPTOR R/65 WITH PICK R/44** (option)



**TOOTH STC/FP** (side scraper)



**TOOTH STC/3/FP** (side scraper)



**PICK R/65/HD** (side scraper)

# SPHEROIDAL CAST-IRON PARALLEL AXIS REDUCTION GEAR

Reduction gears are designed to make penetrating the ground easier. Reduction gears are attached using a pendular system separate from the frame and the rotor and are therefore not affected by stress or deformation. The single reduction gear is also easily detachable.

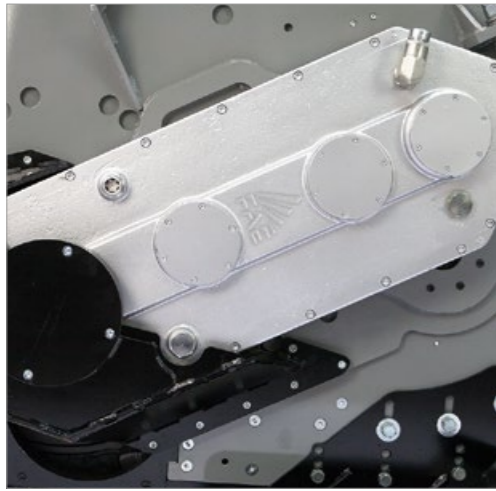

## GEAR REDUCTION SYSTEM

The single and dual gear reduction system, depending on the model, requires no forced hydraulic fluid cooling under any work condition. This component's high heat tolerance is a significant feature as it avoids the need for high maintenance parts such as oil coolers and pumps.

## DUAL LATERAL GEARBOX TRANSMISSION

The dual side geared transmission perfectly transforms engine power into grinding power. Compared to a belt driven transmission, the gearbox transmission offers important advantages such as greater transmission torque, less wear on teeth because of lower rotor speed, more effective ground penetration due to the smaller size.

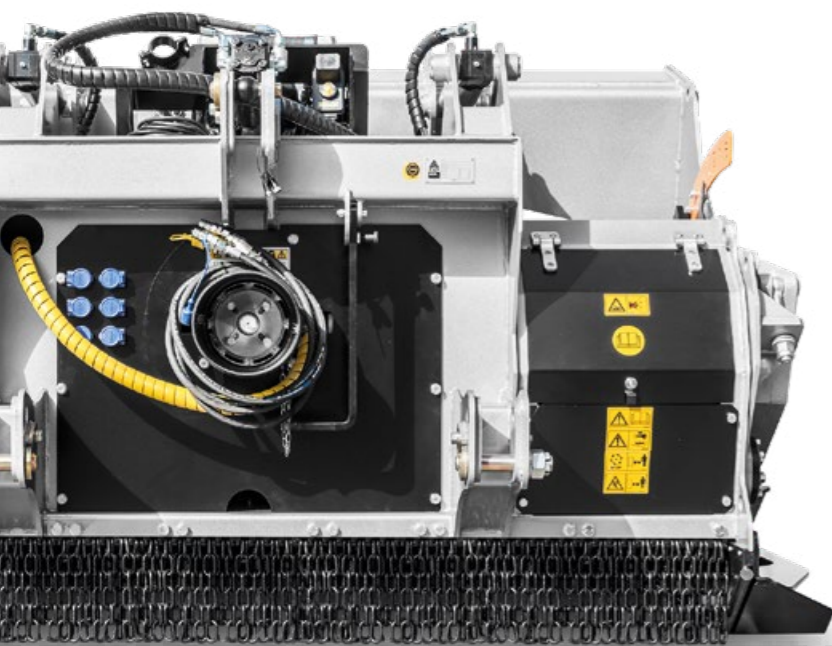

# VARIABLE GEOMETRY MIXING AND GRINDING CHAMBER

This technical solution is unique in the industry. The Variable Geometry Crushing Chamber enables ground penetration with just the rotor, and is adjustable from the cab of the tractor. The volume of the crushing chamber, where the material is blended, is variable. Thus, the deeper the work, the larger the volume of the chamber. Compared with machines that sink into the ground with their frame, the variable geometry crushing chamber reduces resistance with the tractor, lowers fuel consumption, speeds up operations. Saving time.

## BOTTOM SIDE PROTECTION FOR GUARANTEED RELIABILITY, EVEN AT MAXIMUM WORKING DEPTHS

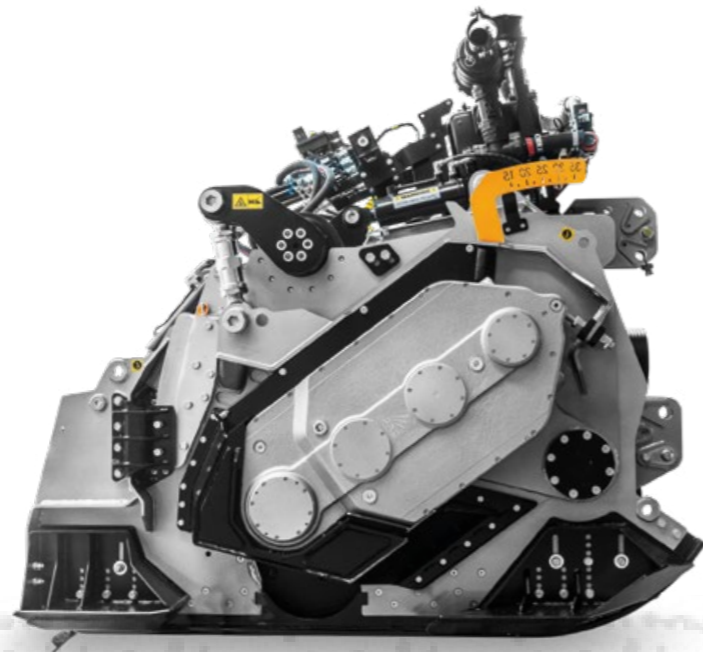

- Guaranteed mixing quality of the material in any situation
- Reduced traction forces and fuel consumption
- Increased operating speeds and greater time savings
- Newly engineered rotor depth control system
- Depth gauge to monitor an achieve ideal depth
- Easily visible from the cab, for precise, efficient depth adjustment

## DEPTH IS ADJUSTED USING 2 CYLINDERS

**MTL:** 0 cm\*  
**MTM:** 4,5 cm\*  
**MTH:** 8,5 cm\*

\*with G/3 rotor

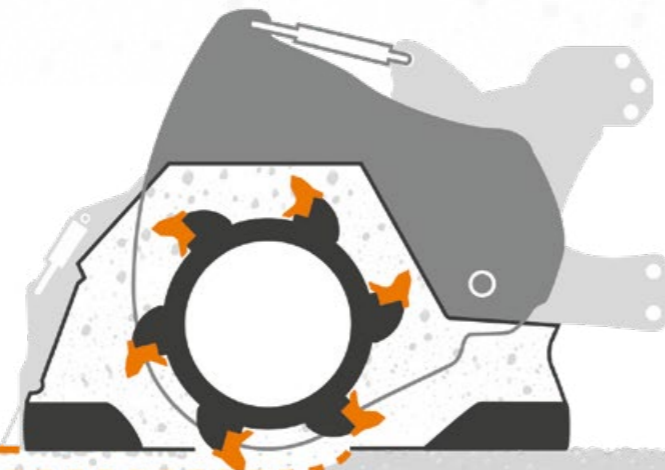

## SPECIALLY DESIGNED TO ACHIEVE A CONSISTENT DEPTH

**MTL:** 15 cm\*  
**MTM:** 25 cm\*  
**MTH:** 32 cm\*

\*with G/3 rotor

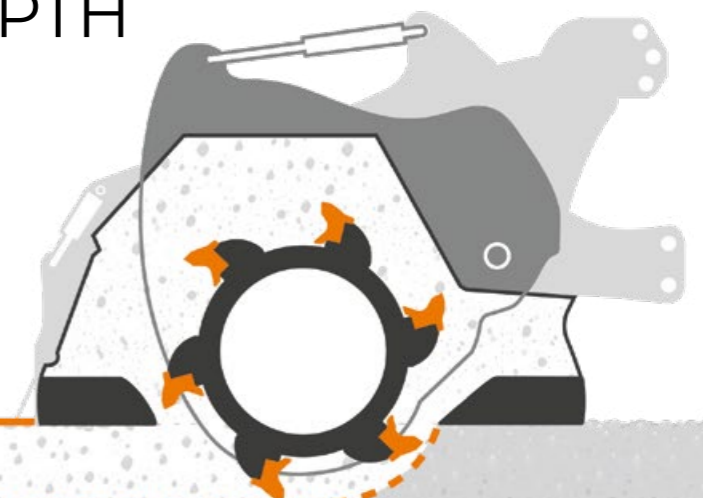

## THE G/3 ROTOR

The heart of FAE technology is the rotor, which grinds rocks and asphalt, turns the ground and evenly mixes lime or cement that is spread over the area to be stabilized. The patented tooth pattern ensures even distribution of the forces over its entire width, limits stress to the structure, reduces power absorption and enables uniform distribution of the output materials.

Guards with easily replaceable parts.

The ends of the rotor and outside tooth holders have wear plates to protect from excessive wear.

Rotors are equipped with different types of tools depending on the application.

### RING LABYRINTH SYSTEM

Standard for all PTO Construction products, the system increases rotor bearing protection from outside contamination. This technical trait makes equipment more reliable, reducing maintenance costs.

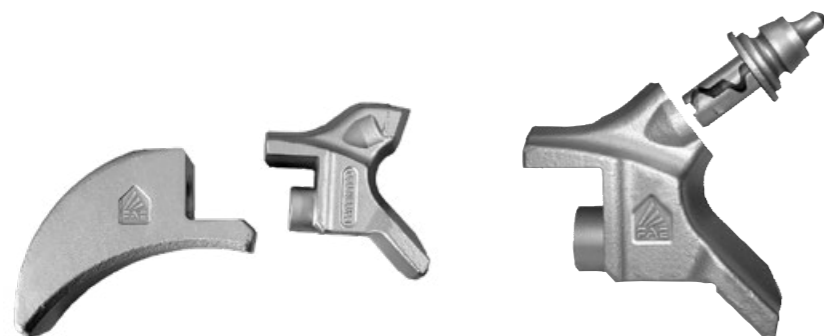
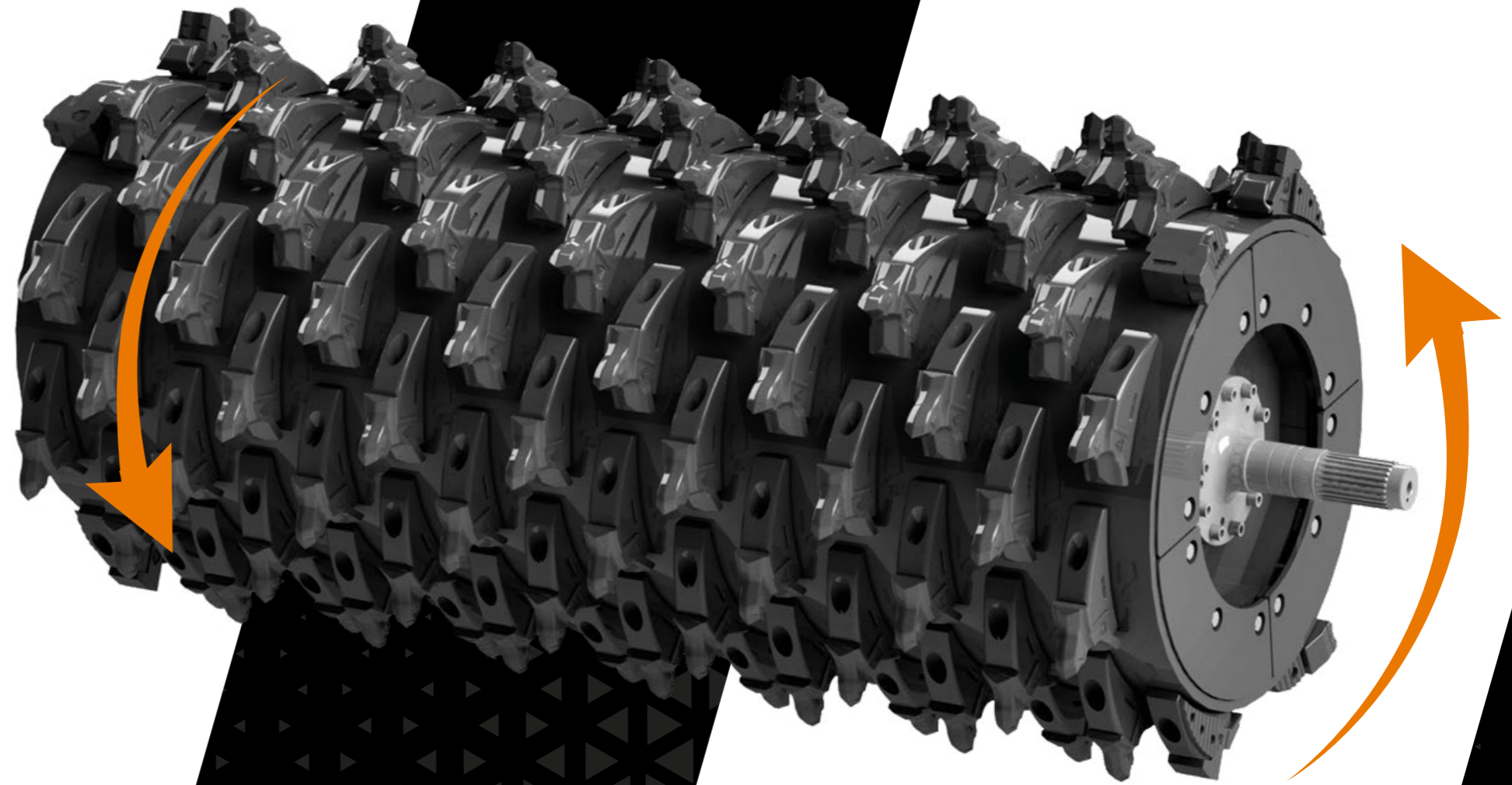

The rotor hubs are interchangeable and made of forged steel for excellent resistance to mechanical stress.

# YOU CAN BE CONFIDENT OF DURABILITY

Our teeth and tooth holders are the result of intensive research and development. The tooth holders are all made of forged steel, and welded to the rotor automatically. Tungsten carbide (Widia®) inserts offer hardness with limited wear and tear.

The special design of FAE teeth guarantees the following advantages:

**1** MAXIMUM RESISTANCE  
TO MECHANICAL STRESS

**2** TOOLS LAST LONGER

**3** MAXIMUM RELIABILITY  
AND PERFORMANCE  
EVEN IN TOUGH TERRAIN

**4** REDUCED OPERATING COSTS

Cutting-edge tooth design ensures the utmost protection for the tooth holder, reducing operating costs.

Improved resistance to mechanical stress and maximum durability are the result of a larger support surface on the rotor.



**TOOTH G/3**  
(standard)



**TOOTH G/3/HD**  
(optional)



**PICK R/44**  
(optional)



**TOOTH STC/FP**  
(side scraper)



**TOOTH STC/3/FP**  
(side scraper)

## GROUND STABILIZING

TOOTH G/3  
PICK R/44



## STABILIZING IN PRESENCE OF ROCKS

PICK R/44  
TOOTH G/3

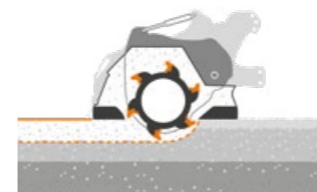

## STONE CRUSHING

TOOTH STC/FP  
(side scraper)  
TOOTH G/3

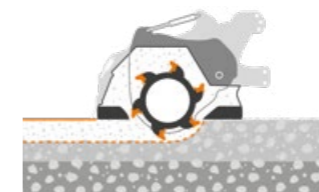

## ASPHALT GRINDING

PICK R/44  
TOOTH G/3

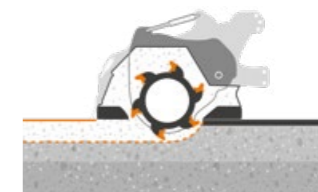

## STUMP GRINDING

TOOTH STC/3/FP  
(side scraper)  
TOOTH G/3



## THE R ROTOR

The heart of FAE technology is the rotor, which grinds rocks and asphalt, turns the ground and evenly mixes lime or cement that is spread over the area to be stabilized. The patented tooth pattern ensures even distribution of the forces over its entire width, limits stress to the structure, reduces power absorption and enables uniform distribution of the output materials.

Guards with easily replaceable parts.

The ends of the rotor and outside tooth holders have wear plates to protect from excessive wear.

A labyrinth ring system avoids dust contamination in the rotor bearing.

Rotors are equipped with different types of tools depending on the application.

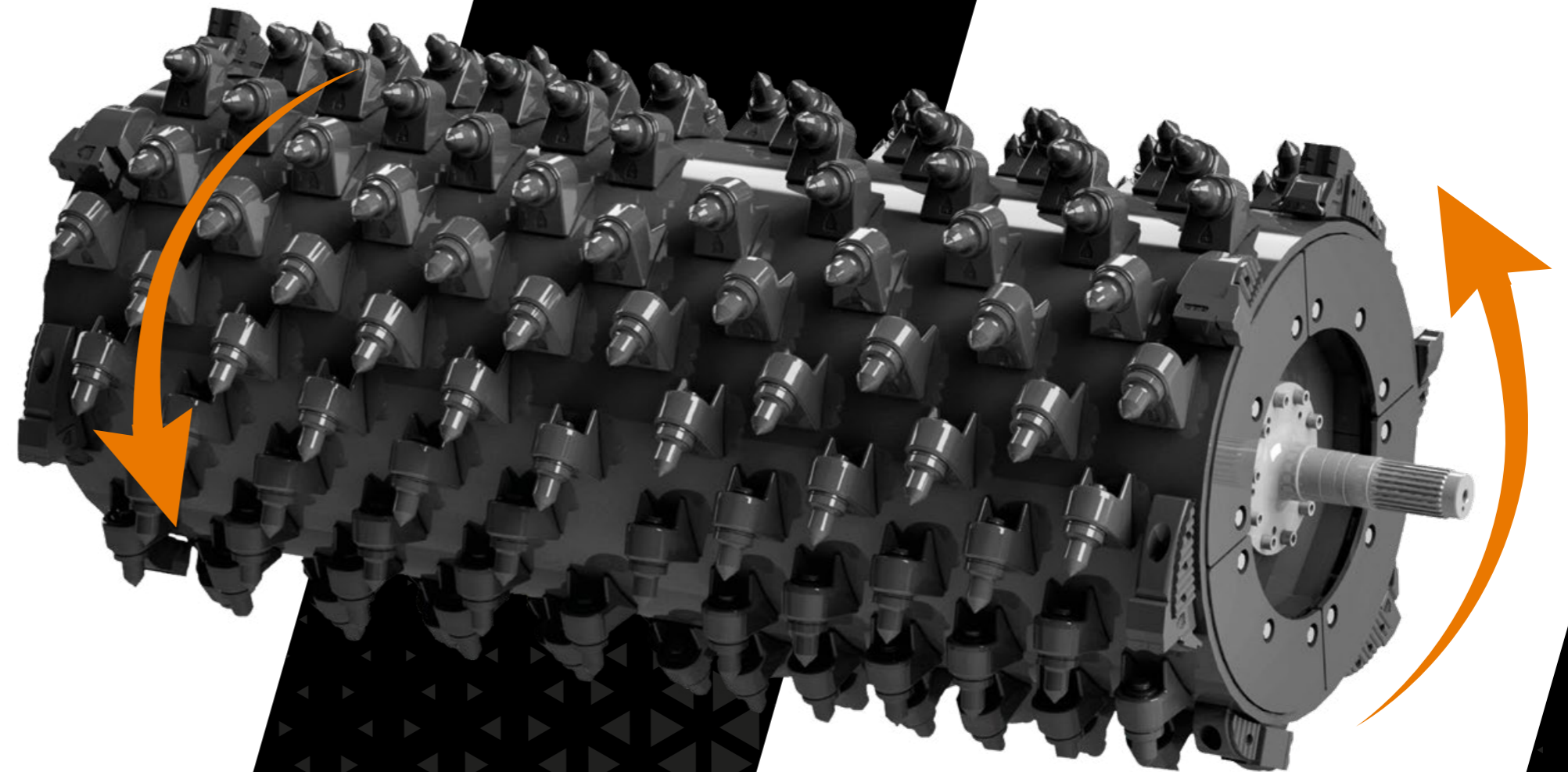

The rotor hubs are interchangeable and made of forged steel for excellent resistance to mechanical stress.

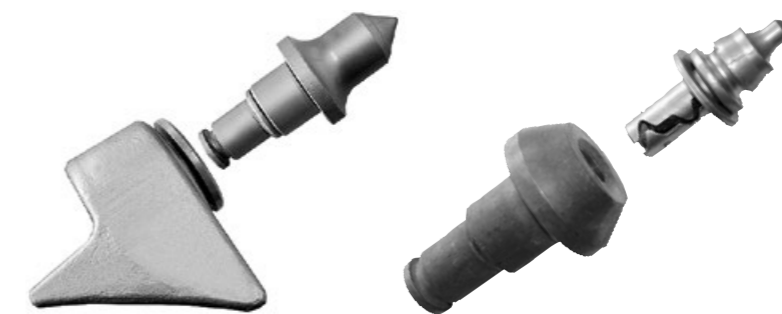

Interchangeable tools that can be easily replaced are symbol of efficiency in every application. A leading-edge technical solution means that the same asphalt shredding tooth (Pick R/44) can be fitted to each rotor.

# YOU CAN BE CONFIDENT OF DURABILITY

Our teeth and tooth holders are the result of intensive research and development. The tooth holders are all made of forged steel, and welded to the rotor automatically. Tungsten carbide (Widia®) inserts offer hardness with limited wear and tear. The special design of FAE teeth guarantees the following advantages:

**1** MAXIMUM RESISTANCE TO MECHANICAL STRESS

**2** TOOLS LAST LONGER

**3** MAXIMUM RELIABILITY AND PERFORMANCE EVEN IN TOUGH TERRAIN

**4** REDUCED OPERATING COSTS

Cutting-edge tooth design ensures the utmost protection for the tooth holder, reducing operating costs. Improved resistance to mechanical stress and maximum durability are the result of a larger support surface on the rotor.



**PICK R/65**  
(standard)



**PICK R/65/HD**  
(optional)



**PICK R/44**  
(optional)



**PICK R/65/HD**  
(side scraper)



**TOOTH STC/FP**  
(side scraper)



**TOOTH STC/3/FP**  
(side scraper)

## GROUND STABILIZING

PICK R/65  
PICK R/65/HD  
PICK R/44



## STABILIZING IN PRESENCE OF ROCKS

PICK R/65/HD  
PICK R/65

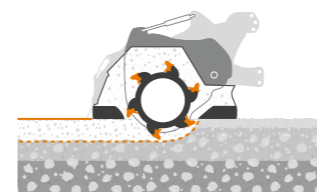

## STONE CRUSHING

PICK R/44  
PICK R/65  
PICK R/65/HD

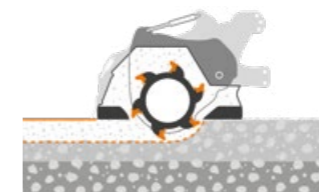

## ASPHALT GRINDING

TOOTH STC/FP  
PICK R/65/HD  
PICK R/44

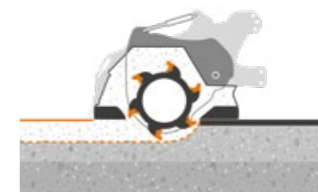

## SLAB GRINDING

TOOTH STC/3/FP  
PICK R/65/HD



# ENDURING THROUGH TIME, DESIGNED FOR EVERY NEED



## REAR GRID

The grid on the rear door helps define the size of the final product. It is easy to adjust mechanically from the outside using the adjustment slots. Its use is indispensable when working on clay-like soils that have a large amount of surface rocks. The grid enables the rear door to be opened so that the soil can flow out without losing the regulation of the average size of the final product.

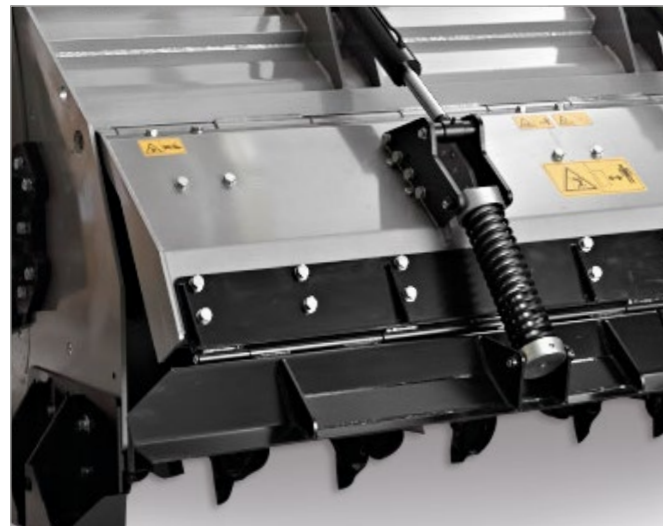

## REAR DOOR

With hydraulic adjustment to regulate the quantity of material in output.

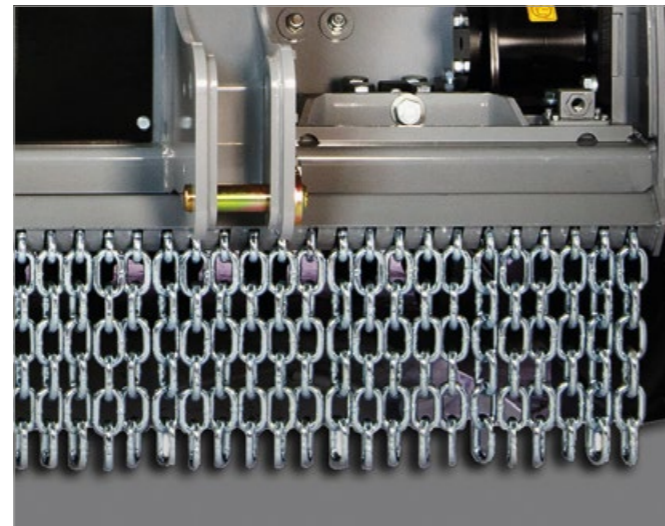

## MATERIAL ENTRY POINT

Comes with hydraulic adjustment to stop rocks from being ejected along the length of the tractor (MTL excluded).

## SIDE WEAR PLATES

On the inner side of the frame are easily replaceable without having to remove the rotor, while ensuring excellent resistance to wear and reduce replacement intervals.

## HARDOX® SECTIONAL WEAR PLATES

Internal Hardox® guards against wear and tear. The sectional plates are easy to replace without having to remove the rotor.

## HARDOX® COUNTER BLADE

Helps to achieve the desired final product size. It is easily replaceable, due to its attachment screws, thus making maintenance fast and easy.

## COUNTER BLADE ADJUSTMENT SYSTEM

Adjustment system that enables the rapid change of position of the Hardox® counter blade depending on material size requirements.





# FOR TOP LEVEL PERFORMANCE THE DIFFERENCE IS IN THE DETAILS

## SPRING LOADED LEVELING BLADE

The spring loaded leveling blade produces an even final product as a result of its engineering and design.

## STRUCTURAL PLATES WELDOX®

To ensure high strength and easy handling.

## SELF-PRIMING WATER SYSTEM PUMP

This system provides a consistent flow rate throughout the water system, no matter the slope of the machine.

## CONTROL PANEL

This is fitted as standard on all machines (MTL excluded). Thanks to 4 indicator lights that signal any failures, the Control Panel allows the oil pressure and temperature to be monitored, together with the alignment of mobile rotor cylinders, for safer machine operations.



## INSPECTION HATCH WITH KEY CLOSURE

The special design of the hatches ensures easy maintenance and inspections. The key closure, specially designed with an incorporated dust screen, allows the quick opening of both hatches in any situation.

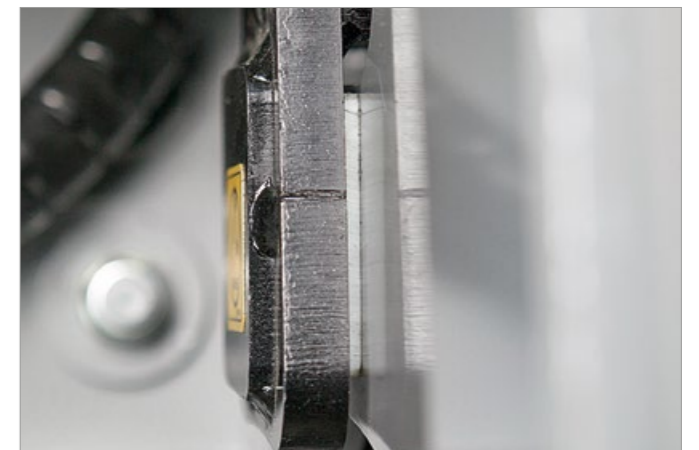

## SUPPORT SKIDS (to prevent the sinking)

The support skids are height adjustable and easily removable to increase working depths. Additional optional features are not necessary for the machine to penetrate to its maximum depth (support skids assembled).

## TEFLON INSERTS

Easily replaceable. They ensure that the two frames slide easily.

# WATER SPRAY SYSTEM (WSS) BASIC AND HIGH FLOW

## WSS BASIC FOR MTL

Compact, convenient and simple system for those who want to carry out asphalt milling and recycling operations. Thanks to a 200-liter tank placed directly on the tractor's front lift and an electric pump that can be operated directly from the tractor cab, the water flow will cool the tools during asphalt processing.

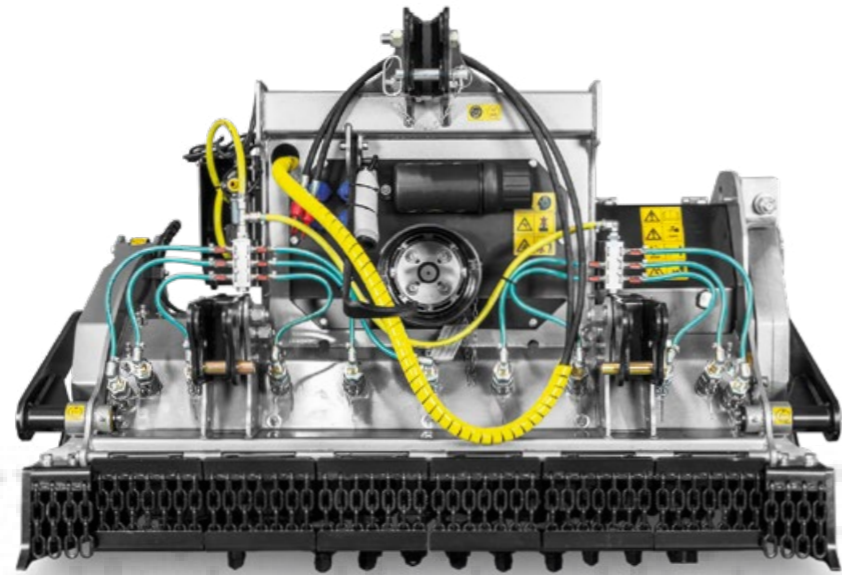

## WSS HIGH FLOW FOR MTL

Water system operated by a hydraulic motor and equipped with a pump with a high flow rate, it has been designed to allow for better mixing; in fact, the high flow rate of the pump not only limits the temperature of the tools, making asphalt milling and recycling operations possible, but also favors the increase of the moisture of the mixed soil, making the machine suitable for stabilization works.

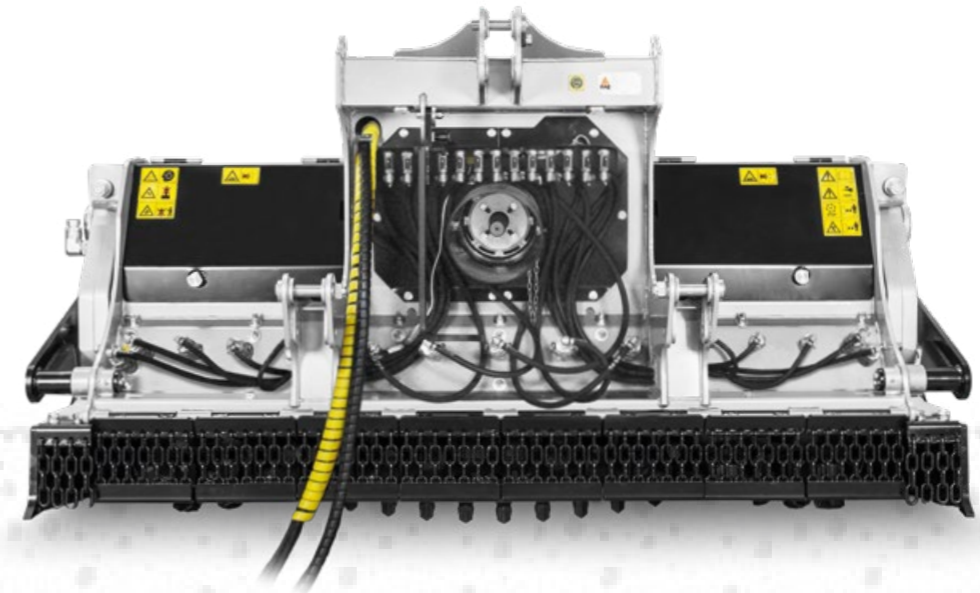

### SWITCH (ON/OFF)

Switch (on/off) located in the tractor cab.

Thanks to this switch, it is possible to easily enable, from the tractor cab, the Water flow.

Flow of a few litres per minute 3-7 l/min.



### WATER TANK

(positioned on the tractor's front mount)

Tank volume 200 litres.



### LOCATED IN THE CAB

1 / Control panel, used to adjust the amount of fluid injected by the stabilizer

2 / Control panel, with display showing the instantaneous flow rate



DATA SHEET	MINIMUM FLOW RATE	MAXIMUM CAPACITY	MAXIMUM PRESSURE
Centrifugal pump	65 l/min	230 l/min	5 bar
Hydraulic engine	-	50 l/min	200 bar

	NO. NOOZLE	MINIMUM FLOW RATE	MAXIMUM CAPACITY
MTL 150	8	70 l/min	145 l/min
MTL 175	8	70 l/min	145 l/min
MTL 200	8	90 l/min	170 l/min
MTL 225	10	135 l/min	230 l/min

# ALL MACHINES CAN BE EQUIPPED WITH A **WATER INJECTION SYSTEM**

(EVEN AT A LATER DATE)

## WATER SPRAY SYSTEM HIGH FLOW (WSS for MTM - MTH)

Thanks to the control panel and display showing the water flow rate, it is possible to easily monitor and adjust, from the tractor cab and in complete safety, the instantaneous value of the liters of water delivered and the overall value from the beginning of the operations.

Water dispensing  
ON (nozzle up)  
or OFF (nozzle down)

Panel display ON/OFF

Check Panel functions

Water capacity  
adjustment (l/min)

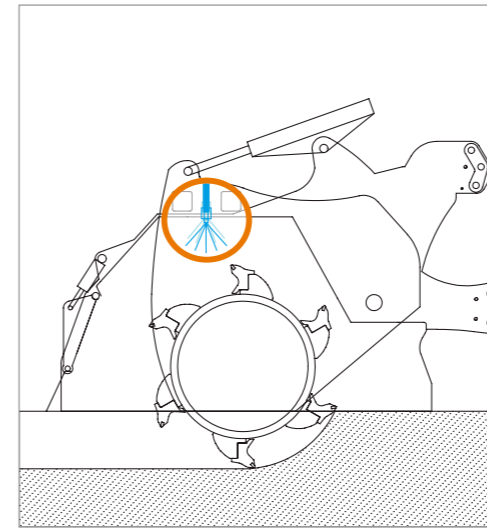

### MIXING FUNCTION

(only for stabilize machines or multitask machines)

This function increases the moisture level in the soil, improves mixing with the stabilising agent during stabilisation operations and optimises the results of the consolidation work. It also helps to ensure proper compaction. This is the ideal solution even for liquid binders mixed directly in the mixing chamber.

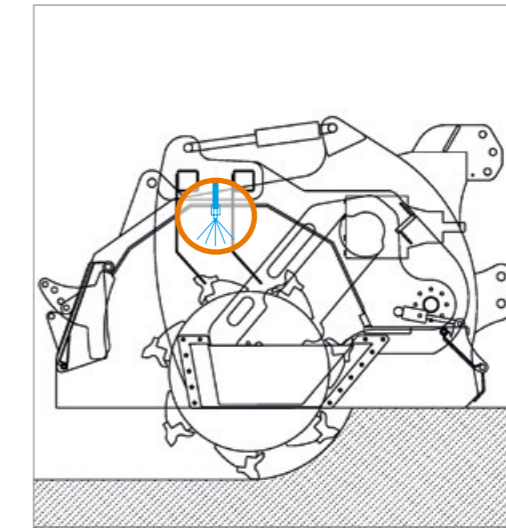

### COOLING FUNCTION

(only for multitask machines)

This function reduces heat build up in the teeth during asphalt grinding operations, thus avoiding overheating of tools and other rotor parts. It greatly reduces tool wear and is recommended for asphalt, cement and very hard rock grinding.



MTM - MTM/HP MTH - MTH/HP	CAPACITY FROM SINGLE NOZZLE AT 3 BAR	CAPACITY FROM SYSTEM
<b>Optional nozzle "1"</b> (80° - 20 l/min)	7.9 l/min	65-110 l/min
<b>Optional nozzle "2"</b> (80° - 40 l/min)	15.8 l/min	115-235 l/min
<b>Optional nozzle "3"</b> (80° - 60 l/min)	24 l/min	150-330 l/min
<b>Standard nozzle</b> (80° - 100 l/min)	39 l/min	210-500 l/min
<b>Optional nozzle "4"</b> (80° - 150 l/min)	59 l/min	240-580 l/min
<b>Optional nozzle "5"</b> (80° - 200 l/min)	79 l/min	260-640 l/min

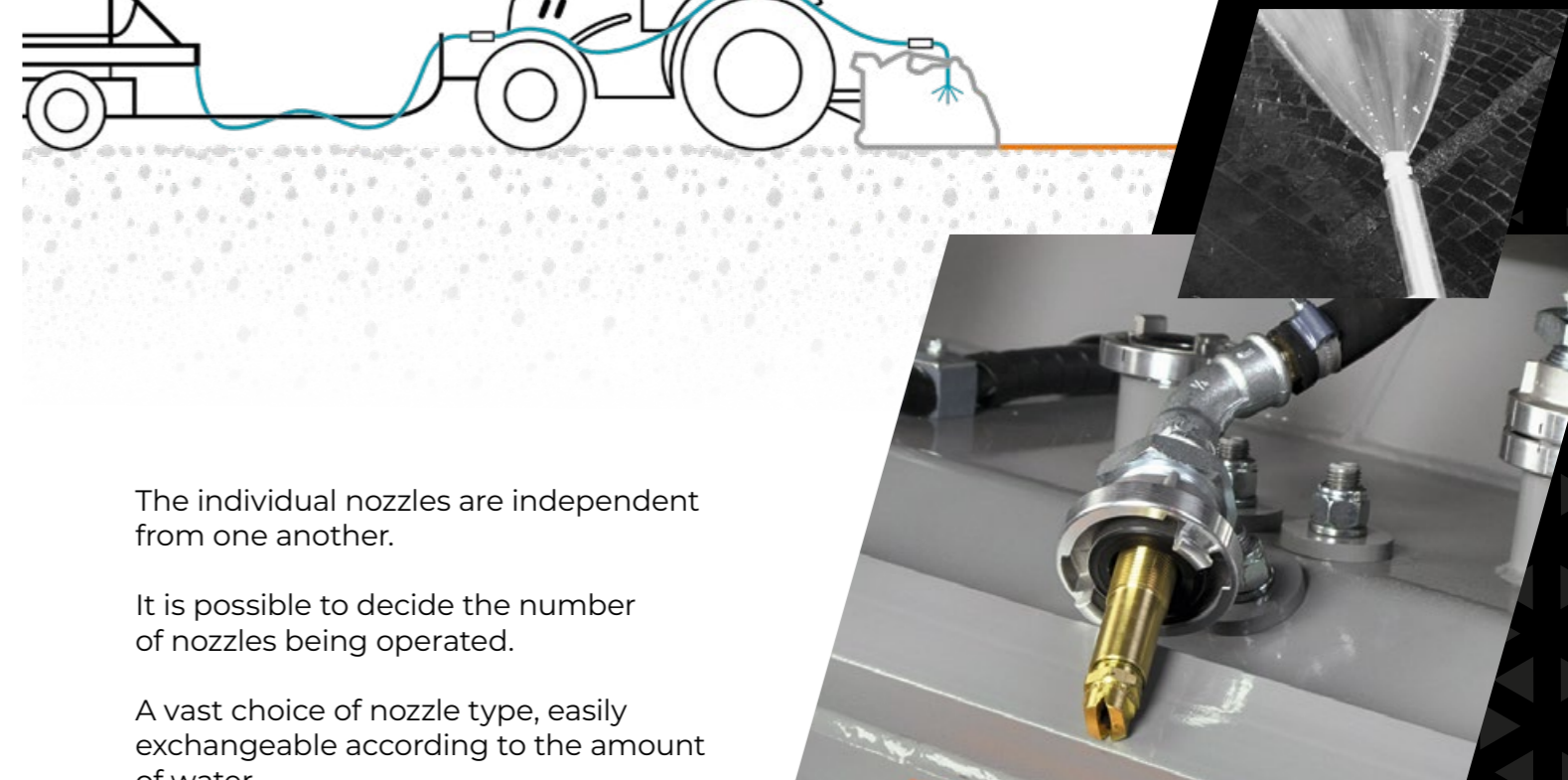

The individual nozzles are independent from one another.

It is possible to decide the number of nozzles being operated.

A vast choice of nozzle type, easily exchangeable according to the amount of water.

# HELPING YOU MAKE THE RIGHT CHOICES

## FCS FULL CONTROL SYSTEM (FCS FOR MTM - MTH)

The FAE automatic injection system, FCS, is a cutting-edge system built for excellent supply and distribution of water and/or to stabilize the fluid binding agent. Using this intuitive system, the operator is able to establish the exact amount of fluid from the display, based on the road surface (l/m<sup>2</sup>) or mixing volume (l/m<sup>3</sup>).



### SETTING STAGE

This allows you to choose the perfect nozzles for the job during the initial stages.



### WORK STAGE

All of the machine's vital parameters are monitored and recorded.



### ANALYSIS STAGE

The software lets you create a work report that can be easily saved to a USB drive (for example the number of m<sup>2</sup> or m<sup>3</sup> processed, water flow, etc.).



The advanced FCS is automatically calibrated according to the speed and depth of the job. The machine's sensors also ensure the correct, automatic operation of this cutting-edge system.

The material is mixed to the moisture ratio required to achieve perfect stabilization.

Compared to manual adjustment, the FCS leaves no room for error and ensure the best possible results in every application. The machine sensors ensure correct and automatic operation of this first-class system.

The system constantly monitors forward feed speed through the ISOBUS connection on the tractor, or via optional radar sensor, while other sensors control the working depth.

A magnetic flow meter ensure the capacity required.

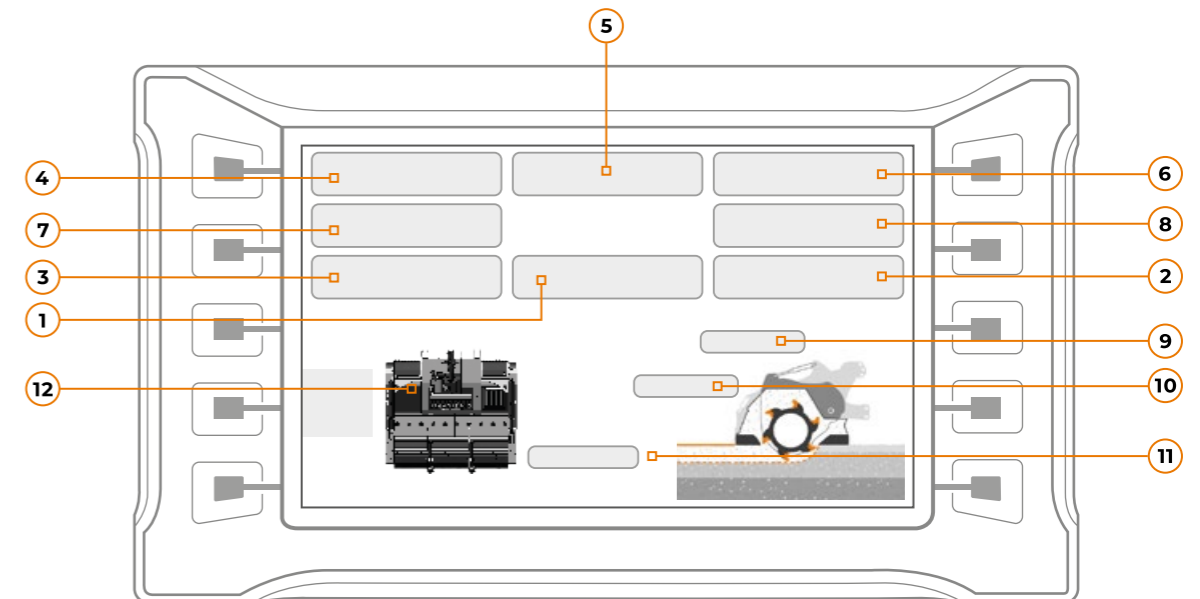

- 1. Current speed
- 2. Current injection flow
- 3. Total flow from the start of the job
- 4. Area covered
- 5. Delivery requirement (l/m<sup>2</sup>)
- 6. Current delivery (l/m<sup>2</sup>)

- 7. Volume mixed
- 8. Current delivered (l/m<sup>3</sup>)
- 9. Rotor movement percentage
- 10. Percentage of rear panel opening
- 11. Working depth
- 12. Number of nozzles open



ALWAYS BY  
YOUR SIDE  
TO **MAKE THE  
DIFFERENCE**



The technical data in this catalog may be altered without prior notice.  
The information and images in this document are not binding.  
The weight is approximate and refers to machine without options.  
The data in this catalog must be confirmed by the sales department.  
Photographs may include accessories and equipment not supplied as standard.  
FAE GROUP S.p.A. reserves the right to make changes at any time, without prior warning.

